METROLOGIC INSTRUMENTS, INC.

**MS860*i* Mini-Slot™
Laser Bar Code Scanner**

Installation and User's Guide

**MLPN 2202
Printed in USA
January 1999**

Locations:

USA Corporate Headquarters

Metrologic Instruments, Inc.
90 Coles Road
Blackwood, NJ 08012
Customer Service: 1-800-ID-METRO
Tel: 609-228-8100
Fax: 609-228-6673
info@metrologic.com
www.metrologic.com

South America

Metrologic Instruments
Rua Flórida, 1.821-5º Andar-Brooklin
CEP 04571-090, São Paulo-SP, Brasil
Outside Brazil:
Tel: 55-11-5505-6568

Europe

Metrologic Instruments GmbH
Dornierstrasse 2
82178 Puchheim b.
Munich, Germany
Tel: 49-89-89019-0
Fax: 49-89-89019-200
metrologic@europe.metrologic.com

ASIA

Metrologic Asia (PTE) Ltd.
31, Kaki Bukit Road 3
#05-08 Techlink
Singapore 417818
Tel: 65-842-7155

Table of Contents

Introduction	1
Unpacking List	2
Scanner Connections to the Host	3
Configuration of the Scanner to the Host System	4
Cloning Feature	5
Version 11 IBM 46XX Scanner	6
Configuring the MS860i-11 Scanner	7
Configuring the IBM 46XX	8
IBM 4683 and 4693 Terminals Driven by a 46XX Store Controller Running 4680.OS or 4690.OS	8
IBM 4684 and 4694 Systems	8
Version 17 Keyboard Wedge Scanner	9
Connection of a MS860i-17 Scanner to a PC	10
Installing the Scanner into a Counter	11
Attaching the Vertical Stand to the Work Surface	12
MS860i Features	13
Touch Plate	14, 15
Visual Indicators	16-19
Volume Settings	20
Labels	21
Depth of Field	22
Depth of Field and Symbol Specification	23, 24

Maintenance 25

Applications and Protocols 25

Appendix A
 Specifications 26, 27

Appendix B
 Default Settings 28-35

Appendix C
 Pin Assignments 36-41

Appendix D
 Warranty and Disclaimer 42, 43

Appendix E
 Notices 44, 45

Appendix F
 Patents 46

Volume Control Card 47, 48

Index 49, 50

Introduction

Metrologic's MS860i Mini-Slot™ Laser Bar Code Scanner is a high-speed, aggressive in-counter scanner. The MS860i unsurpassed scanning accuracy and incorporates the most advanced laser technology in a smaller, yet rugged and durable housing. Designed to be used where counter space is at a premium, the MS860i can be used in a variety of applications.

The MS860i autodiscriminates all standard bar codes, eliminating the need to "key in" unprogrammed codes increasing productivity and efficiency. A code correcting feature (MECCA)© enables the MS860i to decode damaged or truncated codes on the first pass, making the MS860i an excellent choice for reclamation and coupon redemption applications. Each version of the MS860i provides three interface options, with full RS-232 protocol available on every scanner. Three most popular protocols (RS-232, OCIA and Light Pen Emulation) are consolidated into the standard model. For simple PC connectivity, a keyboard wedge interface is also available. Metrologic also offers a patented Hand-Held Option, which allows users to connect the MS941 Hand-Held Scanner to the MS860i for greater scanning versatility.

The MS860i is easy to program via bar code menus from ScanSelect™ Scanner Programming Guide or by using Metrologic's ScanSet™ IBM® compatible software program. Other key features of the MS860i are the auto-off/touch-on plate and easily visible LED indicators mounted on the brushed stainless steel top plate. An optional hardened glass window is also available. Universal adaptor plates make it simple to replace older, larger flatbed scanners with the smaller MS860i. Metrologic also provides a vertical mounting option, so customers can use the MS860i as a projection scanner as well.

Most importantly, the MS860i is easy to afford. It offers a superior, versatile and low cost alternative to larger, more expensive in-counter scanners.

Unpacking List

The shipping carton contains the following:

- ! Installation and User's Guide (MLPN: 2202)
ScanSelect™ Scanner Programming Guide (MLPN: 2186)
Volume Control Card (MLPN: 2346)
- ! MS860i Laser Bar Code Projection Scanner
- ! Installation Plate (MLPN: 45471)
- ! Power Supply (optional)
- ! Communication cable with connection for power supply (optional) or
Communication Cable (optional)
- ! Adaptor Plate or Vertical Stand (optional)

If any item is missing or to order additional items, contact the dealer, distributor or call Metrologic's Customer Service Department at 1-800-ID-METRO or 1-800-436-3876.

Scanner Connections to the Host

To maintain compliance with applicable standards, all circuits connected to the scanner must meet the requirements for SELV (Safety Extra Low Voltage) according to EN 60950. To avoid potential problems, **do not power up the scanner until the communication cable is secured to the host.**

1. Turn off the host system.
2. Connect the 25-pin D-type connector on the scanner's head cable to the communication cable. Connect the other end of the communication cable to the host device. (If the scanner will not receive power from a transformer, skip to Step 5.)
3. If the scanner will receive power from an external power source, check the AC input requirements of the transformer to make sure the voltage matches the AC outlet. (A socket-outlet shall be installed near the equipment and shall be easily accessible.)
4. Plug the transformer into the side of the female D-type connector located on the communication cable. Plug the transformer into the AC outlet to supply power to the scanner.
5. Power up the host system.

Note: When the scanner first receives power, the LEDs will flash and then the scanner will beep once. After the scanner performs this start up sequence, the green LED will remain on for a specified time indicating that the laser is on.

Configuration of the Scanner to the Host System

The scanner is shipped from the factory programmed to a set of default conditions noted in the *Default Settings* section of this guide and in the ScanSelect™ Scanner Programming Guide. The default settings in the ScanSelect guide have an asterisk that appears before the brief definition next to the bar code.

To communicate with the host system properly, it needs to be programmed to meet specific scanning needs. Since each host system is unique, configure the scanner to match the host system requirements. Configure the scanner by entering program mode and scanning the appropriate bar codes that appear in the ScanSelect Scanner Programming Guide. (When using ScanSet™, refer to the ScanSet documentation for information on how to configure the scanner.)

1. Connect the scanner to the host system. (Refer to the *Scanner Connections to the Host* section in this guide)
2. Enter program mode by scanning the ENTER/EXIT program mode bar code as the first bar code after a power up cycle.
(The unit will beep three times.)
3. Scan the appropriate bar code(s) that appear in the ScanSelect Scanner Programming Guide. (Reveal only one bar code to the scanner each time. With your hand, cover the bar code that is not to be scanned.)
4. Exit program mode by scanning the ENTER/EXIT program mode bar code again. (The new options will be saved and the scanner is ready for normal operation.)

Note: Non-RS-232 interfaces chosen in Section B of the ScanSelect Programming Guide do not match the default settings that are loaded when the same interface is selected with ScanSet.

Cloning Feature

To program several scanners with the same settings, use the Cloning feature. This is done by connecting the cloning cable (MLPN: #51544) between two scanners.

1. Turn off both scanners.
2. Connect the cloning cable between the two scanners.
3. Turn both scanners on by plugging in the transformers.
4. Once each scanner is ready, scan the cloning bar code with the scanner that has the settings that need to be transferred to the other scanner.

Version 11 IBM 46XX Scanner

Output Format: IBM RS-485 serial input/output for the 4680 and 4690 (46XX) point-of-sale terminals

The Version 11 46XX interface can be used in several different ways. Both the 46XX terminal and the scanner must be configured to match each other.

Warning: Power to the scanner and 46XX terminal should be turned off before making physical connection.

The 4680 and 4690 series terminals have different types of physical ports for connecting bar code scanners. Scanner ports include Port 5B, Port 17, and Port 9? (? = A, B, C, or E). A Port 9 type connector is present on all versions of the 46XX families of terminals. That is one reason why it is the normal point of connection for Metrologic scanners. Another reason is that there is enough 12 volt power available to operate many Metrologic scanners. If your terminal configuration requires the use of a different physical port for connecting bar code scanners, contact Metrologic to get particular adaptor cable information.

All devices use a common communications bus inside the 46XX terminal, despite what port that is in use for the physical connection. Each device has a different address that it uses when it communicates. The terminal must be configured to look for a device at a logical address.

The IBM 1520 mode/address was selected as a default because it was the first IBM 46XX family scanner to support UPC/EAN, Code 39 and Interleaved 2 of 5 (I 2 of 5). The Version 11 scanner formats Codabar, Code 128, and Code 93 using the Code 39 function code designation supported by the IBM device driver for this scanner type. Other emulation modes currently available are the IBM 3687-2 Port 17 fixed scanner and the Port 9B IBM 4500 CCD hand-held bar code reader. The use one of these other emulation modes may be needed depending on which operating system (4680.OS, 4690.OS, POS/DOS or DOS/RIPPS) is in use at your site.

Note: The IBM 4683 and IBM 4684 terminals have a good proven track record of supplying power to Metrologic scanners. The IBM 4693 and IBM 4694 terminals may be restricted from supplying power to certain scanner models. Specifically, Metrologic currently recommends using an external power supply for the scanner when connecting to an IBM 4694. Metrologic has no recommendations at this time for IBM 4693 terminals.

Configuring the MS860i-11 Scanner

Located in the Version 11 scanner are two computer boards. One computer board is for decoding and the other for 46XX IO processing. The decode board is configured using ScanSet™ or ScanSelect™ while the IO board is configured with an internal DIP Switch bank.

For UPC/EAN scanning, the decode board should be set as follows:

- Enable IBM 4680 Communication
- Enable UPC/EAN
- Beep after Transmit
- Enable Communication Timeouts
- Transmit UPC-A Check Digit
- Transmit UPC-E Check Digit

These settings configure the decode board to beep after transmitting the data to the terminal device driver. If the data does not clear the communications buffer within two seconds, it is discarded without giving the operator a good scan indication. This accommodates newer versions of the IBM device drivers that enable/disable scanning in many different situations.

The default setting of the interface board is to emulate the IBM 1520 hand scanner that supports UPC/EAN and alphanumeric code types. The following is a list of switch settings for the internal interface board that handles the 46XX SIOC communications.

There are eight DIP switches on the board that are both software and hardware switches.

Switch 1	Switch 2	Emulation Mode
OFF	OFF	Port 5B, IBM 1520 Model 2 Laser Scanner (default setting)
OFF	ON	Port 9B, CCD (IBM 4500/Opticon)
ON	OFF	Port 17, IBM 4014 Adaptor for 3687-2 to 468X
ON	ON	Reserved
Switch 3		Reserved (Should be OFF)
Switches 4, 5, 6, and 7		Must be ON
Switch 8		Should be OFF (Reserved)

Configuring the IBM 46XX

The 4683 and 4693 terminals are configured on the store controller. The 4684 and 4694 terminals are typically configured on the individual terminals. Follow the appropriate guide for your type of equipment.

IBM 4683 and 4693 Terminals Driven by a 46XX Store Controller Running 4680.OS or 4690.OS

Access the terminal configuration menu on the store controller. If not already selected, select an IBM 1520 laser hand scanner (4680.OS Port 5B), an IBM 4500 hand-held bar code reader (CCD, 4680.OS Port 9B), or an IBM 3687-2 fixed scanner (4680.OS Port 17) that matches the configuration of your scanner. Regarding the 4690.OS, at the time of this printing, Metrologic does not know exactly which terminal port configuration screen is used for selecting scanners. It should be listed under the Port 9A, 9B, 9C, or 9E sections. The 4693 terminal has a Port 5B that was originally used for the IBM 1520 scanner. While IBM has withdrawn this product, it was not clear how terminal configuration and device driver support would be provided for the installed base of users.

Save the configuration and activate it for the desired terminals. Download the configuration to the terminal(s) per standard procedures.

IBM 4684 and 4694 Systems

Initialize the RIPPS drivers for a hand scanner if hand scanner emulation was selected. Initialize the RIPPS drivers for a “POS scanner” if the 3687-2 scanner has been selected.

Version 17 Keyboard Wedge Scanner

The MS860i scanner (version 17) provides keyboard emulation by converting the scanned bar code data to the PC keyboard scan code equivalent. The following are the supported keyboard and country types:

PC Type

- ! AT (includes IBM® PS/2 and compatible models 50, 55, 60, 80)
- ! XT
- ! PS/2 (includes IBM PC and compatible models 30, 70, 8556)

Keyboard Country Type

- | | |
|------------------|-----------|
| ! USA | ! Germany |
| ! France | ! Spain |
| ! Italy | ! Belgium |
| ! United Kingdom | ! Swiss |

With the appropriate communication cable, the scanner will also provide an RS-232 or light pen emulation interface. When configuring the scanner for one interface versus another, change all necessary parameters for that particular interface. For instance, when configuring the scanner for keyboard wedge emulation, recall defaults, select the PC type, keyboard country type and intercharacter delay. For further information, refer to the ScanSelect Scanner Programming Guide or ScanSet Scanner Configuration Guide.

Connection of a MS860i-17 Scanner to a PC

To maintain compliance with applicable standards, all circuits connected to the scanner must meet the requirements for SELV (Safety Extra Low Voltage) according to EN 60950.

1. Attach the adaptor to the communication cable if needed.
2. If the PC is on, exit your application and turn the PC off.
3. Disconnect the keyboard from the PC. Plug the communication cable to the PC and the keyboard. Connect the 25-pin D-type connector on the scanner's head cable to the communication cable. (Refer to Figure 1)
4. Check the AC input requirements of the transformer to make sure the voltage matches the AC outlet. (A socket outlet shall be installed near the equipment and shall be easily accessible.)
5. Plug the transformer into the side of the female D-type connector located on the communication cable. Plug the transformer into the AC outlet to supply power to the scanner. Turn the PC on.

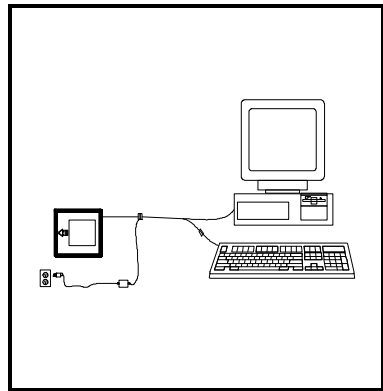

Figure 1

Note: Once the scanner is connected to the PC, the PC can be turned on and will operate normally even if the scanner's transformer is not plugged in. However, bar codes will not be read until power is applied to the scanner.

When the scanner first receives power, the LEDs will flash and the scanner will beep once. After the scanner performs this start up sequence, the green LED will remain on for a specified time indicating the laser is on.

For information concerning keyboard wedge features, refer to the section, *Version 17 Keyboard Wedge Scanner*.

Installing the Scanner into a Counter

Metrologic has designed three plates to accommodate in-counter installation of the scanner. Included automatically with the purchase of the scanner is Metrologic part #45471, Installation Plate. The universal and replacement plates are available at an extra charge. Contact the distributor, dealer or Metrologic to order one of these plates.

Metrologic Part Number 45471, Installation Plate:

This plate is designed for use in counters with no previous cut outs. No routing is necessary for a flush fit as the stainless steel top is only .60mm (.024") thick. The cut out measurements are 180.34mmL x 175.26mmW (7.1" x 6.9"). The final cut out must not be greater than 1.5mm (1/16") or less than the exact measurement. For easier installation, use the mounting template that accompanies this guide.

Metrologic Part Number 45474, Universal Plate:

This plate is designed to fit into an existing cut out up to 292.1mmL x 508mmW (11.5" x 20").

Metrologic Part Number 45470, Replacement Plate:

This plate is designed to fit into a cut out that previously contained an MS260 or MS362 scanner. This plate fits into the existing 293.62mmL x 245.36mmW (11.56" x 9.66") cut out.

Attaching the Vertical Stand to the Work Surface

With the Metrologic stand (Part #45472), there is a choice of four directions the scanner can be positioned for greater flexibility. Figure 2 illustrates one direction that can be chosen. The stand requires a mounting space of 91.44mmL x 165.1mmW (3.6" x 6.5") to stabilize the stand. Since the arrow of the scanner in Figure 3 is pointing to the right, items must be presented to the scanner from left to right.

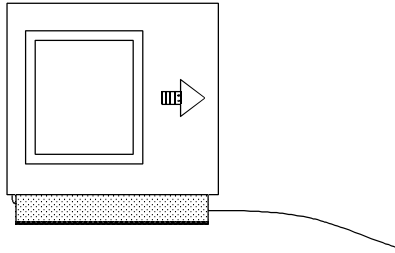

Figure 2

1. Drill four holes into the work surface that correspond with the holes in the 161.93mm x 85.73mm (6.38" x 3.38") base of the stand. (See Figure 3)
2. Screw the stand to the work surface with the four screws that are provided.
3. Place the scanner into the cradle of the stand.
4. Align the two holes located on the back of the scanner with two holes on the stand.
5. Screw the scanner to the stand.

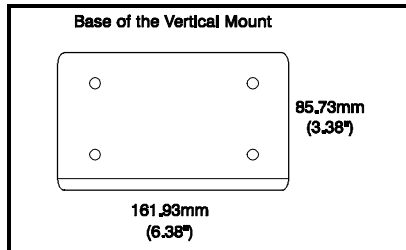

Figure 3

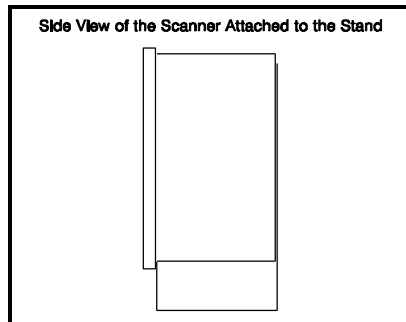
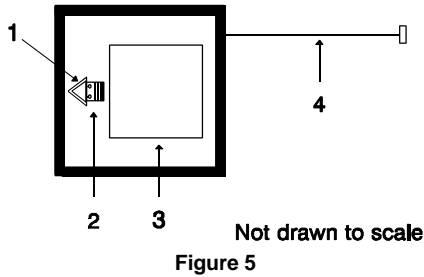

Figure 4

MS860i Features

Becoming familiar with the features of the MS860i will help when operating the scanner. The following illustration and list explain the pertinent parts.



- 1 Touch Plate** When a specified time has elapsed without any scanning, the unit will enter a “standby” mode. Touching the touch plate arrow on the top cover will reactivate the scanner.
- 2 Green and Red LEDs** When the green LED is on, this indicates the unit is receiving power and the laser is on. When the red LED flashes on, the scanner has read a bar code successfully. When the red light turns off, communication to the host is complete.
- 3 Scanner Window** This aperture emits laser light.
- 4 Head Cable** This cable can be connected directly to the host device or to a communication cable.

Touch Plate

The scanner will enter “standby” when it remains dormant for a time. When the scanner’s computer is on “standby,” touching the touch plate will “wake up” the scanner and activate the laser. When the green LED comes on, the scanner is powering up for full operation. After approximately three seconds, the scanner will be ready to operate.

The default touch plate timeout is ten minutes. However, this can be changed through ScanSet or by scanning a bar code in Section C of the ScanSelect Programming Guide. The available times are two minutes, thirty minutes or no timeout.

Plaque de palpeur

Le scanner passe en mode 'Stand-by' quand il n'est pas utilisé pendant une certaine période. Si le calculateur du scanner se trouve en mode 'Stand-by', le contact de la plaque de palpeur "réveille" le scanner et active le laser. L'allumage de la diode verte indique que le scanner se met en service en attente d'utilisation. Au bout d'environ 3 secondes, le scanner est prêt à servir.

La temporisation standard de plaque de palpeur est de 10 minutes. Ceci peut toutefois être modifié avec ScanSet ou par lecture d'un code barres au chapitre C du manuel de programmation ScanSelect. Les durées disponibles sont deux minutes, trente minutes ou même aucune temporisation.

Sensorplatte

Der Scanner tritt in den 'Stand-by'-Modus ein, wenn er für einen bestimmten Zeitraum untätig geblieben ist. Befindet sich der Rechner des Scanners im 'Stand-by'-Modus, "weckt" die Berührung der Sensorplatte den Scanner und aktiviert den Laser. Das Aufleuchten der grünen Leuchtdiode zeigt an, daß der Scanner sich für volle Betriebsbereitschaft einschaltet. Nach etwa drei Sekunden ist der Scanner betriebsbereit.

Der Standard-Sensorfeld-Timeout liegt bei zehn Minuten. Dies kann jedoch geändert werden durch ScanSet oder Einlesen eines Barcodes in Abschnitt C des ScanSelect Programmierhandbuchs. Die verfügbaren Zeiträume sind zwei Minuten, dreißig Minuten oder gar kein Timeout.

Piastra sensore

Se lo scanner è rimasto disattivato per un determinato periodo esso passa in modalità 'stand-by'. Quando il calcolatore dello scanner si trova in modalità 'stand-by', occorre toccare la piastra sensore per "svegliare" lo scanner ed attivare il laser. L'accensione del diodo luminoso verde indica che lo scanner si accende per diventare completamente pronto. Dopo circa tre secondi lo scanner ha raggiunto la condizione "pronto".

Il timeout standard della zona sensore è regolato su dieci minuti. Questo valore può, però, essere modificato con lo ScanSet oppure con la lettura di un codice a barre, come descritto nella sezione C del Manuale di programmazione ScanSelect. Gli intervalli possibili sono due minuti, trenta minuti oppure nessun timeout.

Visual Indicators

There is a red and green LED at the top of the scanner. When the scanner is on, the flashing or stationary activity of the LEDs indicates the status of the scan and scanner.

Steady Green

When the laser is on, the green LED is also on. This occurs when the touch plate has been touched. The green LED will remain on until the touch plate timeout elapses or until the scanner turns off.

Steady Green; Red Flash

When the scanner successfully reads a bar code, the red LED will flash then beep once. If this does not happen, then the bar code has not been successfully read.

Steady Red and Green

After a successful scan, the scanner transmits the data to the host device. When the host is not ready to accept the information, the scanner's red LED will remain on until the data can be transmitted.

Alternating Red and Green

This indicates the scanner is in program mode.

Steady Red

This indicates the scanner is in ScanSet mode.

No Red or Green LED

There are two reasons why the LEDs will not be illuminated. First, if the scanner is receiving power and the LEDs are not on, then the scanner has remained dormant for a specified time and the laser has turned off. To reactivate the unit, touch the touch plate. Secondly, if the scanner is not receiving power from the host or transformer, then the LEDs will not turn on.

Flashing Red

This indicates the scanner has experienced a laser subsystem failure. Return the unit for repair at an authorized service center.

Signaux optiques

Sur la partie supérieure du scanner se trouvent une diode LED rouge et une diode LED verte. Quand le scanner est sous tension, les diodes rouge et verte clignotantes ou allumées vous informent sur l'état du scanner.

Ni la diode rouge, ni la diode verte n'est allumée

Il existe deux raisons possibles pour que les diodes ne s'allument pas. Premièrement: si le scanner reçoit de l'énergie sans que les diodes ne s'allument, le scanner est resté sans servir pendant une certaine période et le laser est désactivé. Pour le réactiver, touchez le palpeur infrarouge. Deuxièmement: quand le scanner ne reçoit de l'énergie ni de l'ordinateur central, ni du transformateur, les diodes restent éteintes.

Diode verte reste allumée

Quand le laser est en service, la diode verte s'allume également. C'est le cas quand vous avez touché le palpeur. La diode verte reste allumée tant que la temporisation de l'infrarouge dure ou jusqu'à ce que le scanner soit désactivé.

Diode verte reste allumée; diode rouge clignotante

Après lecture avec succès d'un code barres par le scanner, la diode rouge se met à clignoter, suivie d'un bip sonore unique. Si la diode rouge ne clignote pas ou quand aucun bip sonore n'est émis, cela signifie que le code barres n'a pas pu être lu avec succès.

Diode rouge et verte reste allumées

Une fois le palpé effectué avec succès, le scanner transmet les données à l'ordinateur central. Si ce dernier n'est pas prêt à recevoir les données, la diode rouge du scanner s'allume jusqu'à ce que les données puissent être transmises.

Diode rouge et verte en alternance

Indique que le scanner se trouve en mode de programmation.

Diode rouge reste allumée

Indique que le scanner se trouve en mode ScanSet.

Diode rouge clignotante

Indique une panne de laser pendant le palpé. Veuillez envoyer votre appareil chez un concessionnaire pour réparation.

Optische Anzeigen

Auf dem Scanner befinden sich eine rote und eine grüne Leuchtdiodenanzeige. Bei eingeschaltetem Scanner geben Ihnen die blinkenden oder feststehenden Leuchtdiodenanzeigen Aufschluß über den Abtast- und Scannerstatus.

Weder rote noch grüne Leuchtdiodenanzeige

Es gibt zwei mögliche Gründe, weshalb die Leuchtdiodenanzeigen nicht aufleuchten. Erstens: Wenn der Scanner mit Strom versorgt wird und die Leuchtdiodenanzeigen nicht aufleuchten, so ist der Scanner für einen bestimmten Zeitraum untätig geblieben und der Laser ist abgeschaltet. Berühren Sie das Sensorfeld zur Reaktivierung der Einheit. Zweitens: Wenn der Scanner weder vom Hostrechner noch vom Transformator Energie erhält, leuchten die Leuchtdiodenanzeigen ebenfalls nicht auf.

Feststehende grüne Anzeige

Wenn der Laser eingeschaltet ist, leuchtet die grüne Leuchtdiodenanzeige ebenfalls auf. Dies ist der Fall, wenn das Sensorfeld berührt wurde. Die grüne Leuchtdiodenanzeige leuchtet solange auf, bis das Sensorfeld-Timeout abgelaufen ist oder bis der Scanner abgeschaltet wird.

Feststehende grüne Leuchtanzeige; rote Blinkanzeige

Nach erfolgreichem Lesen eines Barcodes durch den Scanner blinkt die rote Leuchtdiode auf, gefolgt von einem einmaligen Piep-Signal. Blinkt die rote Leuchtdiodenanzeige nicht auf oder sendet der Scanner kein einmaliges Piep-Signal aus, so konnte der Barcode nicht erfolgreich gelesen werden.

Feststehende rote und grüne Leuchtanzeige

Nach erfolgreichem Abtasten überträgt der Scanner die Daten an das Hostgerät. Falls das Hostgerät zur Datenannahme nicht bereit ist, leuchtet die rote Leuchtdiodenanzeige solange auf, bis die Daten übertragen werden können.

Alternierende rote und grüne Leuchtanzeige

Zeigt an, daß sich der Scanner im Programmiermodus befindet.

Feststehende rote Leuchtanzeige

Zeigt an, daß sich der Scanner im ScanSet-Modus befindet.

Aufblinkende rote Leuchtanzeige

Zeigt an, daß beim Scanner ein Laserausfall vorliegt. Bringen Sie das Gerät zur Reparatur in ein Vertragsservicecenter.

Segnali ottici

Sullo scanner si trovano due diodi luminosi: uno rosso e uno verde. Quando lo scanner è inserito, i diodi luminosi, che possono o essere accesi in continuazione o lampeggiare, Vi informano sullo stato della scansione e dell'apparecchio.

Né il diodo luminoso rosso né quello verde sono accesi

Vi sono due possibili cause se i diodi luminosi non sono accesi. Prima causa: se lo scanner viene alimentato e i diodi luminosi non sono accesi, lo scanner è rimasto disattivato per un determinato periodo e il laser è spento. Per riattivare l'unità dovrete toccare la zona sensore. Seconda causa: se lo scanner non viene alimentato né dal calcolatore host né dal trasformatore, i due diodi luminosi non sono accesi.

Il diodo luminoso verde è acceso

Quando il laser è inserito, è acceso anche il diodo luminoso verde. Questo si ha quando la zona sensore è stata toccata. Il diodo luminoso verde è acceso fino al raggiungimento del timeout della zona sensore oppure fino allo spegnimento dello scanner.

Il diodo luminoso verde è acceso; quello rosso lampeggia

Dopo la lettura riuscita di un codice a barre da parte dello scanner il diodo luminoso rosso lampeggia e quindi viene emesso un unico segnale beep. Se il diodo luminoso rosso non lampeggia oppure lo scanner non emette un segnale beep unico, ciò significa che la lettura del codice a barre non è riuscita.

Sono accesi sia il diodo luminoso rosso che quello verde

Dopo la scansione riuscita lo scanner trasmette i dati all'host. Se l'host non è pronto per accettare i dati, il diodo luminoso rosso dello scanner è acceso fino a che i dati possono essere trasmessi.

Il diodo luminoso rosso e quello verde sono accesi in alternanza

Ciò indica che lo scanner si trova nella modalità di programmazione.

Il diodo luminoso rosso è acceso

Ciò indica che lo scanner si trova nella modalità ScanSet.

Il diodo luminoso rosso lampeggia

Ciò indica che lo scanner ha un guasto a livello del laser. Fate riparare l'apparecchio da un centro di assistenza autorizzato.

Volume Settings

There are four volume settings available: low, medium, high and no volume. The operator can temporarily change the volume of the scanner by scanning the bar codes on the volume control card. To change the volume of the scanner permanently, enter program mode and scan the appropriate volume setting bar code in Section C of the ScanSelect Programming Guide or use ScanSet.

Note: A copy of the volume control card is at the end of this guide.

Labels

There is one label located inside the window of the scanner noting that the device is a CDRH Class Iia laser product and IEC 825 LASERKLASSE 1. Also, on each scanner is a label located on the back of the unit. This label contains information such as the model number, date of manufacture, and serial number. The following are samples of these labels:

<p>Complies with 21 CFR Chapter 1 subchapter J. Class Iia laser product. Avoid long-term viewing of direct laser light.</p>	<p>Metrologic Metrologic Instruments, Inc. Blackwood, New Jersey, USA Contains no user serviceable components. Warranty void if case is opened. Complies with FCC/VDE Class A see manual.</p>		<p>This product complies with US DHS Standards 21 CFR Chapter 1 Subchapter J, Class Iia Laser Product. Avoid long-term viewing of direct laser light.</p> <p>Eviter toute exposition prolongée de la vue au rayonnement laser direct. Appareil laser Classe Iia.</p>
	<p>Manufactured Blackwood, NJ. February 1996 Model : MS880I-F1 Barcode Scanner Serial # : XXXXXXXXXX XXXXXXXXXXXX XXXXXXXXXXXX Patent #5,081,362; #1,268,257; #5,216,232 Worldwide Patents Pending</p>	<p>11-30V ~~~</p>	 <p>CAUTION: Laser light when opened. DO NOT STARE INTO BEAM.</p>

Depth of Field

Through the glass at the front of the scanner, safe, low powered laser beams are projected in a complex pattern that resembles a spider web. Each of the five scan fields that generate the scan pattern extends to a range of 127mm (5.0"). This range begins from the face of the scanner window and extends from the unit for a distance of 127mm (5.0") measured along the scanning beam at the center of each scan segment. This 0.0mm - 127mm (0" - 5") range is the depth of field for the MS860i scanner (see figure 6).

The scan pattern is projected at an angle away from the touch plate (approximately 20 degrees, overall). As the scan fields move outward, they expand. Like an image expands from a film projector as it moves toward the screen at a movie theater, the scan pattern projects out to a well-defined region. Any label that is facing toward the scanner can be read at any point within the scanning field.

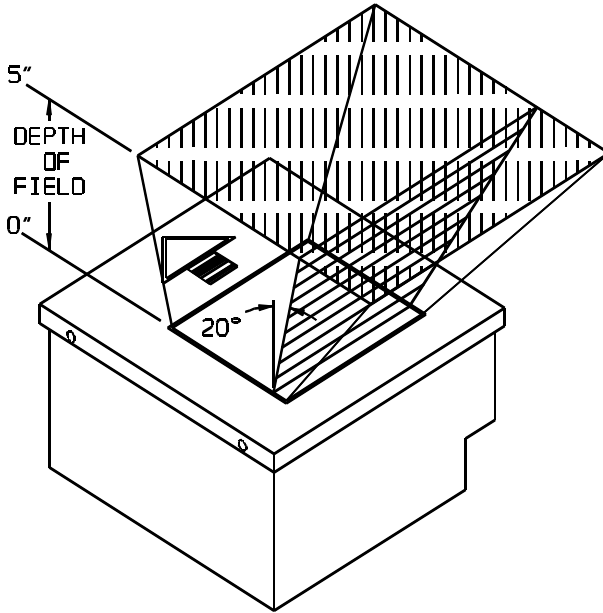

Figure 6

Depth of Field and Symbol Specification (See Figure 7)

Code Type	Minimum Small Element Mil. (1/1000")	Code Density	Depth of Field
UPC/EAN	10.4	80%	0" - 5"
UPC/EAN	13.0	100%	0" - 6.5"
Code 39	7.5	High	0" - 3"
Code 39	12.0	Medium	0" - 6"
Code 39	21.0	Low	0" - 8"
I 2 of 5	7.5	High	0" - 3"
I 2 of 5	12.0	Medium	0" - 6"
I 2 of 5	21.0	Low	0" - 8"
Codabar	6.5	High	0" - 3"
Codabar	9.8	Medium	0" - 5"
Codabar	13.0	Low	0" - 6.5"
Code 93	10.4	80%	0" - 5"
Code 93	13.0	100%	0" - 6.5"
Code 128	10.4	80%	0" - 5"
Code 128	13.0	100%	0" - 6.5"

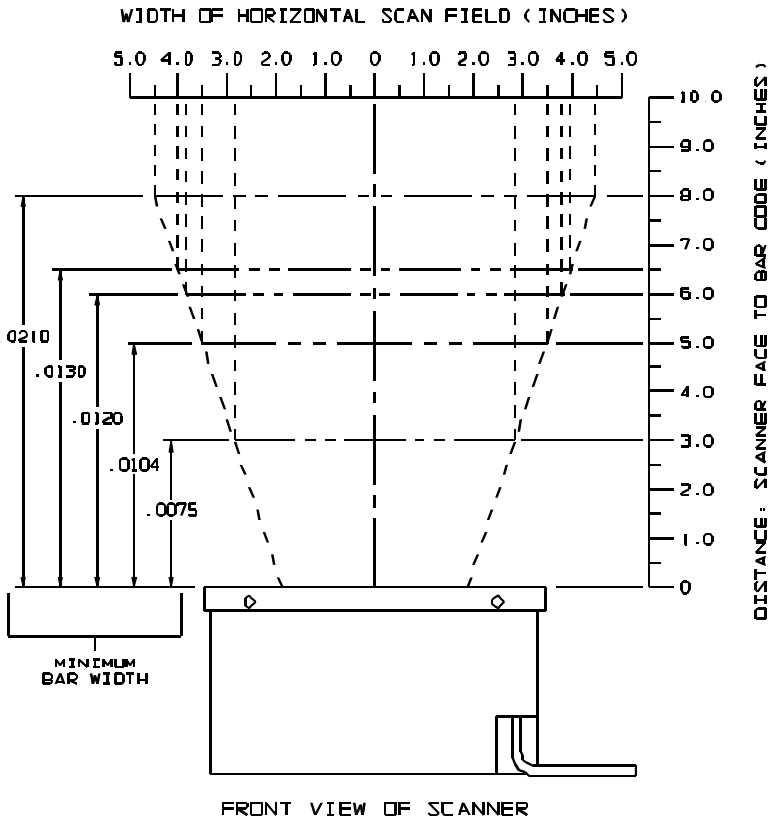

Figure 7

Maintenance

Smudges and dirt can interfere with the proper scanning of a bar code. Therefore, the output window will need occasional cleaning.

1. Spray glass cleaner onto lint free, non-abrasive cleaning cloth.
2. Gently wipe the scanner window.

Applications and Protocols

The model number on each scanner includes the scanner number and communications protocol.

Version Identifier	Communication Protocol(s)
1	RS-232, OCIA, Light Pen Emulation
2	Parallel Output (OCR A/B)
26	RS-232, OCIA, Light Pen Emulation, Multi-drop RS-422
11	IBM 46XX - RS-485, RS-232, OCIA
17	Keyboard Wedge, RS-232, Light Pen

Appendix A

Specifications

Application:	In-Counter Laser Bar Code Scanner
Light Source:	VLD 675 ± 5 nm, Maximum output 1mW
CDRH:	CLASS IIa laser product
IEC:	Class 1 laser product, EN 60825/09.91
UL/CSA/TUV:	UL Listed, UL 114; CSA certified, C22.2 No. 950; TUV certified, GS Mark, EN 60825 and EN 60950
EMI:	Complies with FCC & VDE Class A

Mechanical

Dimensions:	175mm x 173mm x 97mm (6.9"L x 6.8"W x 3.8"D)
Weight (w/o cable):	2.45kg (5.4 lbs.)
Orientation:	May be used in any orientation
Top Cover:	Brushed stainless steel, with auto-off/touch-on plate; Easily replaced window
Cable Length:	1.8m (6') terminated with 25-pin connector

Electrical

Power Consumption:	8 watts, host system or tabletop power supply
Voltage:	Input: 11-30 VDC
Operating Current:	350mA @ 24 VDC
Standby Current:	175mA @ 24 VDC
DC Transformers:	6061 (220V AC in) and 6062 (120V AC in) output 24 VDC @ 750mA

Specifications subject to change without notice.

Patent Numbers: 5,216,232; 5,081,342; 1,268,257; Other Patents Pending

Operational

Depth of Field:	0.0mm - 127mm (0" - 5")
Minimum Bar Width:	0.075 inches
Scan Speed:	2000 scan lines per second
Scan Pattern:	5 scan fields: 1 horizontal, 4 at angles
Exit Angle:	70E
Indicators:	LED: green=laser on; red=good read
Beeper Operation:	3 tones for "Good Read"
Maintenance Required:	Clean window periodically
Decode Capability:	Standard programming automatically discriminates: UPC - A & E; EAN - 8 & 13; JAN - 8 & 13; Codabar; Code 128; Code 39; Code 93; I 2 of 5, Code 11; MSI Plessey. Other symbologies are supported as well as supplemental codes. For further information, contact Metrologic.
System Interfaces:	RS-232C/OCIA, Parallel, IBM® 468X/469X, Light Pen Emulation, Multi-drop RS-422, Keyboard Wedge
Print Contrast:	35% minimum reflectance difference
Roll, Pitch, Yaw:	360E, 60E, 60E

Environmental

Storage Temperature:	-40EC - 60EC (-40EF - 140EF)
Operating Temperature:	0EC - 35EC (32EF - 95EF)
Humidity:	5% - 95% relative humidity, non-condensing
Light Levels:	Up to 3200 foot candles
Ventilation:	None required
Shock:	100g for 1ms
ESD:	8 kV IEC 801-2
Contaminants:	Sealed to resist airborne particulate

Specifications subject to change without notice.

Appendix B

Default Settings

The scanner is shipped from the factory programmed to a set of default conditions. The default parameter of the scanner has an asterisk (*) in the charts on the following pages. If an asterisk is not in the default column then the default setting is Off or Disabled.

Every communication does not support every parameter. If the communication supports a parameter listed in the charts on the following pages, a check mark will appear.

For the scanner to communicate with your host system properly, program it to meet the specific scanning needs. Since each host system is unique, change the default settings to match the host system requirements. For information on how to change the default settings, refer to the *Configuration of the Scanner to the Host System* section or the ScanSelect™ Scanner Programming Guide.

Parameter	Default	OCIA	IBM 46XX	Key Wedge	RS-232*	Parallel	Light Pen
UPC/EAN	*	T	T	T	T	T	T
Code 128	*	T	T	T	T		T
Code 93	*	T	T	T	T		T
Codabar	*	T	T	T	T		T
Interleaved 2 of 5 (ITF)	*	T	T	T	T		T
MOD 10 Check on ITF		T	T	T	T		T
Code 11		T	T	T	T		T
Code 39	*	T	T	T	T		T
Full ASCII Code 39		T	T	T	T		T
MOD 43 Check on Code 39		T	T	T	T		T
MSI Plessey		T	T	T	T		T

Parameter	Default	OCIA	IBM 46XX	Key Wedge	RS- 232*	Parallel	Light Pen
MSI Plessey 10/10 Check Digit		T	T	T	T		T
MSI Plessey MOD 10 Check Digit	*	T	T	T	T		T
UK Plessey		T	T	T	T		
Airline 2 of 5		T	T	T	T		
Telepen		T	T	T	T		
MECCA		T	T	T	T	T	T
Paraf Support		T	T	T	T		T
Matrix 2 of 5		T	T	T	T		
EAN-8	*	T	T	T	T	T	T
EAN-13	*	T	T	T	T	T	T
UPC-E	*	T	T	T	T	T	T
UPC-A	*	T	T	T	T	T	T
ITF Symbol Lengths	Var.	T	T	T	T	T	T
Minimum Symbol Length	04	T	T	T	T	T	T
Symbol Length Lock	None	T	T	T	T	T	T
SWEDA	*					T	
Fujitsu						T	
OMRON						T	
IBM Parallel						T	

Parameter	Default	O CIA	IBM 46XX	Key Wedge	RS- 232*	Parallel	Light Pen
Bars High as Code 39	*						T
Spaces High as Code 39							T
Bars High as Scanned							T
Spaces High as Scanned							T
DTS/SIEMENS		T					
DTS/NIXDORF	*	T					
NCR F		T					
NCR S		T					
Poll Light Pen Source							T
Light Pen Extra Transition Before Bar Code							T
Multi-drop Address							
Beeper Tone	Normal	T	T	T	T	T	T
Fast Beep		T	T	T	T	T	T
Volume Setting	Loudest	T	T	T	T	T	T

Parameter	Default	OCIA	IBM 46XX	Key Wedge	RS-232*	Parallel	Light Pen
Beep/Transmit Sequence	Before	T	T	T	T	T	T
Communication Timeout	None	T	T	T	T	T	T
Razzberry Tone on Timeout		T	T	T	T	T	T
Three Beeps on Timeout		T	T	T	T	T	T
No Beeps on Timeout		T	T	T	T	T	T
Touch Plate Timeout	10 Min.	T	T	T	T	T	T
No Same Symbol Timeout		T	T	T	T	T	T
Infinite Same Symbol Timeout		T	T	T	T	T	T
Same Symbol Rescan Timeout: 100 msec		T	T	T	T	T	T
Same Symbol Rescan Timeout: 200 msec		T	T	T	T	T	T
Same Symbol Rescan Timeout: 500 msec	*	T	T	T	T	T	T
Same Symbol Rescan Timeout: 1250 msec		T	T	T	T	T	T
Same Symbol Rescan Timeout: 2000 msec		T	T	T	T	T	T

Parameter	Default	OCIA	IBM 46XX	Key Wedge	RS-232*	Parallel	Light Pen
Scanability	Off				T		
Scan Count Mode	Off				T		
Normal Depth of Field	*	T	T	T	T	T	T
Intercharacter Delay	1 msec	T		T	T	T	
Scan Buffer	1	T	T	T	T	T	T
Transmit UPC-A Check Digit	*	T	T	T	T	T	
Transmit UPC-E Check Digit		T	T	T	T	T	
Expand UPC-E		T	T	T	T	T	
Convert UPC-A to EAN-13		T	T	T	T	T	
Transmit Lead Zero on UPC-E		T	T	T	T	T	
Convert EAN-8 to EAN-13		T	T	T	T	T	
Transmit EAN-13 Check Digit	*	T	T	T	T	T	
Transmit EAN-8 Check Digit	*	T	T	T	T	T	
Transmit UPC-A Number System	*	T	T	T	T	T	
Transmit Codabar Start/Stop Characters		T	T	T	T	T	
CLSI Editing		T	T	T	T		

Parameter	Default	O CIA	IBM 46XX	Key Wedge	RS- 232*	Parallel	Light Pen
Transmit Mod 43 Check Digit on Code 39		T	T	T	T		
Transmit Code 39 Stop/Start Characters		T	T	T	T		
Transmit Mod 10/ITF		T	T	T	T		
Transmit Code 11 Check Digit		T	T	T	T		T
Transmit MSI Plessey Check Digits		T	T	T	T		
Transmit UK Plessey Check Digits		T	T	T	T		
Parity	Space				T		
Baud Rate	9600				T		
8 Data Bits					T		
7 Data Bits	*				T		
Transmit Sanyo ID Characters				T	T		
Shell Schulmberger Formatting				T	T		
SNI Beetle Mode				T	T		
French PC Term					T		
Transmit AIM ID Characters				T	T		
Nixdorf ID				T	T		

Parameter	Default	OCIA	IBM 46XX	Key Wedge	RS- 232*	Parallel	Light Pen
UPC Prefix				T	T		
UPC Suffix				T	T		
STX Prefix				T	T		
ETX Suffix				T	T		
Carriage Return	*			T	T		
Line Feed	*			T	T		
Tab Prefix				T	T		
Tab Suffix				T	T		
"DE" Disable Command					T		
"FL" Laser Enable Command					T		
DTR Handshaking Support					T		
RTS/CTS Handshaking					T		
Character RTS/CTS	*				T		
Message RTS/CTS					T		
XON/XOFF Handshaking					T		
ACK/NAK					T		
5 Retries on ACK/NAK Time-out					T		
Keyboard Country Type	USA			T			

Parameter	Default	OCIA	IBM 46XX	Key Wedge	RS-232*	Parallel	Light Pen
Keyboard Type	AT			T			
Caps Lock				T			
Alt Mode				T			
Inter Scan Code Delay	800 Fsec			T			
Transmit FOH Break Code (AT and PS/2 keyboards)	*			T			
Special Software is required for the following:							
Two Digit Supplements		T	T	T	T		T
Five Digit Supplements		T	T	T	T		T
Bookland		T	T	T	T		T
977 (2 digit) Supplemental Requirement		T	T	T	T		T
Supplements are not Required	*	T	T	T	T		T
Two Digit Redundancy	*	T	T	T	T		T
Five Digit Redundancy		T	T	T	T		T
200 msec to Find Supplement		T	T	T	T		T
100 msec to Find Supplement	*	T	T	T	T		T
Code 128 Coupon Extended Code		T	T	T	T		
Code 128]C1 Extended Code Format		T	T	T	T		

Appendix C

Pin Assignments

Version “1” Pin Assignments for RS-232, OCIA and Light Pen Emulation

The version “1” scanner head cable is terminated with a male 25-pin D-type connector. Connecting the scanner to the host device, may require a communication cable. The communication cable may include a connection for a transformer or it may be designed to draw power directly from the host device. This can be ordered when the scanner is purchased.

The version “1” scanner is designed to be used for RS-232, OCIA or Light Pen Emulation communication.

The following is a list of the pin assignments. The pin numbers are impressed on the head cable’s connector.

Pin	Function
1	AC Shield Ground
2	RS-232 Receive Input
3	RS-232 Transmit Output
4	CTS Input
5	RTS Output
6	Reserved
7	Signal Ground
8 - 12	Reserved
13	Earth Ground
14	Power Ground 1
15	Light Pen Source
16	Light Pen Data
17	OCIA Clock In Return
18	OCIA Clock In
19	Power (11 - 30 volts) DC
20	DTR Input
21	OCIA Clock Out
22	OCIA Clock Out Return
23	OCIA RDATA
24	OCIA RDATA Return
25	Power Ground 2

Version “2” Pin Assignments for Parallel Communication

The version “2” scanner head cable is terminated with a male 25-pin D-type connector. Connecting the scanner to the host device, may require a communication cable. The communication cable may include a connection for a transformer or it may be designed to draw power directly from the host device. This can be ordered when the scanner is purchased.

The version “2” scanner is designed to be used for Parallel communication.

The following is a list of the pin assignments. The pin numbers are impressed on the head cable’s connector.

Pin	Function
1	AC Shield Ground
2	RS-232 Receive Input
3	RS-232 Transmit Output
4	CTS Input
5	RTS Output
6	Reserved
7	Signal Ground
8	Reserved
9	Edit Check
10	EOT
11	Data Ready
12	Adaptor Ready
13	Earth Ground
14	Power Ground 1
15	Light Pen Source
16	Light Pen Data
17	Data 1
18	Data 2
19	Power (11 - 30 volts) DC
20	DTR Input
21	Data 3
22	Data 4
23	Data 5
24	Data 6
25	Power Ground 2

Version “11” Pin Assignments for RS-485

The version “11” scanner head cable is terminated with a male 25-pin D-type connector. Connecting the scanner to the host device, may require a communication cable. The communication cable may include a connection for a transformer or it may be designed to draw power directly from the host device. This can be ordered when the scanner is purchased.

The version “11” scanner is designed to be used primarily with IBM® 46XX series of electronic cash registers. It can also be configured to communicate using the full RS-232 and OCIA protocol.

The following is a list of the pin assignments. The pin numbers are impressed on the head cable’s connector.

Pin	Function
1	AC Shield Ground
2	RS-232 Receive Input
3	RS-232 Transmit Output
4	CTS Input
5	RTS Output
6	Reserved
7	Signal Ground
8 - 12	Reserved
13	Earth Ground
14	Power Ground 1
15	468X -B
16	468X +A
17	OCIA Clock In Return
18	OCIA Clock In
19	Power (11 - 30 volts) DC
20	DTR Input
21	OCIA Clock Out
22	OCIA Clock Out Return
23	OCIA RDATA
24	OCIA RDATA Return
25	Power Ground 2

Version “17” Pin Assignments for Keyboard Wedge, RS-232 and Light Pen Emulation

The version “17” scanner head cable is terminated with a male 25-pin D-type connector. Connecting the scanner to a PC, requires a communication cable and a transformer. Connecting the communication cable to a PC, may require an adaptor cable. This can be ordered when the scanner is purchased.

The version “17” scanner is designed to be used as a keyboard wedge. However, with the appropriate communication cable, the scanner will also provide an RS-232 or light pen emulation interface. When configuring the scanner for one interface versus another, change all necessary parameters for that particular interface. For instance, when configuring the scanner for keyboard wedge emulation, recall defaults, select the PC type, keyboard country type and intercharacter delay. For further information, refer to the ScanSelect Scanner Programming Guide or ScanSet Scanner Configuration Guide.

The following is a list of the pin assignments. The pin numbers are impressed on the head cable’s connector.

Pin	Function	Pin	Function
1	AC Shield Ground	14	Power Ground 1
2	RS-232 Receive Input	15	Light Pen Source
3	RS-232 Transmit Output	16	Light Pen Data
4	CTS Input	17	PC Data
5	RTS Output	18	PC Clock
6	Reserved	19	Power (11 - 30 volts) DC
7	Signal Ground	20	DTR Input
8 - 10	Reserved	21	Keyboard Clock
11	PC +5 Volts DC	22	Keyboard Data
12	Ground	23 - 24	Reserved
13	Earth Ground	25	Power Ground 2

Version “3” Pin Assignments for Multi-drop RS-422

The version “3” scanner head cable is terminated with a male 25-pin D-type connector. Connecting the scanner to the host device, may require a communication cable. The communication cable may include a connection for a transformer or it may be designed to draw power directly from the host device. This can be ordered when the scanner is purchased.

The version “3” scanner is designed to be used for Multi-drop RS-422 communication.

The following is a list of the pin assignments. The pin numbers are impressed on the head cable’s connector.

Pin	Function
1	AC Shield Ground
2	RS-232 Receive Input
3	RS-232 Transmit Output
4	CTS Input
5	RTS Output
6	Reserved
7	Signal Ground
8	Reserved
9	Master Data +
10	Master Data -
11	Slave Data +
12	Slave Data -
13	Earth Ground
14	Power Ground 1
15	Light Pen Source
16	Light Pen Data
17	OCIA Clock In Return
18	OCIA Clock In
19	Power (11 - 30 volts) DC
20	DTR Input
21	OCIA Clock Out
22	OCIA Clock Out Return
23	OCIA RDATA
24	OCIA RDATA Return
25	Power Ground 2

Version "26" Pin Assignments for RS-422

The version "26" scanner head cable is terminated with a male 25-pin D-type connector. Connecting the scanner to the host device, may require a communication cable. The communication cable may include a connection for a transformer or it may be designed to draw power directly from the host device. This can be ordered when the scanner is purchased.

The version "26" scanner is designed to be used for RS-422 communication.

The following is a list of the pin assignments. The pin numbers are impressed on the head cable's connector.

Pin	Function
1	AC Shield Ground
2	RS-232 Receive Input
3	RS-232 Transmit Output
4	CTS Input
5	RTS Output
6	Reserved
7	Signal Ground
8	Reserved
9	Reserved
10	Reserved
11	Reserved
12	Reserved
13	Earth Ground
14	Power Ground 1
15	Light Pen Source
16	Light Pen Data
17	OCIA Clock In Return
18	OCIA Clock In
19	Power (11 - 30 volts) DC
20	DTR Input
21	OCIA Clock Out
22	OCIA Clock Out Return
23	OCIA RDATA
24	OCIA RDATA Return
25	Power Ground 2

Appendix D

Warranty and Disclaimer

Limited Warranty

Products manufactured by Metrologic have a 2-year limited warranty from date of manufacture.

This warranty is limited to repair, replacement or refund at Metrologic's discretion. Faulty equipment must be returned to the Metrologic facility in Blackwood, New Jersey or Puchheim, Germany. To do this, contact Metrologic Customer Service/Repair for a Returned Material Authorization (RMA) number.

In the event that it is determined that the equipment failure is covered under the warranty, Metrologic shall, as its sole option, repair, replace with a functionally equivalent unit, or refund an amount equal to the purchase price to the original purchaser, whether distributor, dealer/reseller, or retail consumer, and return the equipment to the customer without charge for service or return freight.

This limited warranty does not extend to any Product which, in the sole judgment of Metrologic, has been subjected to misuse, neglect, improper installation or accident, nor does it extend to any Product which has been repaired or altered by anyone who is not a Metrologic authorized representative.

THIS LIMITED WARRANTY, EXCEPT AS TO TITLE, IS IN LIEU OF ALL OTHER WARRANTIES, EXPRESS OR IMPLIED, INCLUDING MERCHANTABILITY OR FITNESS FOR ANY PARTICULAR PURPOSE, ARISING BY LAW, CUSTOM OR CONDUCT. THE RIGHTS AND REMEDIES PROVIDED HEREIN ARE EXCLUSIVE AND IN LIEU OF ANY OTHER RIGHTS OR REMEDIES. IN NO EVENT SHALL METROLOGIC BE LIABLE FOR INDIRECT, INCIDENTAL, OR CONSEQUENTIAL DAMAGES, INCLUDING, WITHOUT LIMITATION, ANY INJURY TO PROPERTY OR PERSON OR EFFECT ON BUSINESS OR PROFIT, AND IN NO EVENT SHALL ANY LIABILITY OF METROLOGIC EXCEED THE ACTUAL AMOUNT PAID TO METROLOGIC FOR THE PRODUCT.

Metrologic Instruments, Inc.
90 Coles Road
Blackwood, NJ 08012

Customer Service Department
1-800-ID-METRO (1-800-436-3876)
TEL: 609-228-8100
FAX: 609-228-6673

Metrologic Instruments GmbH
Dornierstrasse 2
82178 Puchheim b.
Munich, Germany
TEL: 49-89-89019-0
FAX: 49-89-89019-200

Disclaimer

Metrologic Instruments, Inc. and the author or authors make no claims or warranties with respect to the contents or accuracy of this publication, or the product it describes, including any warranties of fitness or merchantability for a particular purpose. Any stated or expressed warranties are in lieu of all obligations or liability for any damages, whether special, indirect, or consequential, arising out of or in connection with the use of this publication or the product it describes. Furthermore, the right is reserved to make any changes to this publication without obligation to notify any person of such changes. Metrologic also reserves the right to make any changes to the product described herein.

Exclusion des responsabilités

Metrologic Instruments, Inc. et le/les auteur(s) ne sont ni garants, ni responsables pour l'exhaustivité et la correction des informations contenues dans cette brochure - que ce soit relativement à leur teneur et à l'exactitude - ou pour le produit qui y est décrit. Ils ne sont en outre responsables d'aucune garantie de propriété ou de qualité pour un usage particulier. Toutes les assurances nommées ou exprimées excluent toute garantie ou responsabilité pour les dommages spéciaux, indirects ou des suites de l'utilisation de cette brochure ou du produit qui y est décrit respectivement. en rapport avec l'emploi de cette brochure et du produit qui y est décrit. Il leur est également réservé le droit de procéder à des modifications de cette brochure sans avoir à en avertir qui que ce soit. Metrologic se réserve en outre le droit de procéder à des modifications du produit qui y est décrit.

Haftungsausschluß

Metrologic Instruments, Inc. und der/die Autor(en) übernehmen keinerlei Gewähr und haften nicht für die Richtigkeit im Hinblick auf Inhalt oder Genauigkeit der Angaben dieser Veröffentlichung oder des hierin beschriebenen Produkts. Sie übernehmen ebenso keinerlei Eignungsgarantie oder Gewährleistung durchschnittlicher Qualität für einen bestimmten Zweck. Alle benannten oder ausdrücklichen Zusicherungen schließen sämtliche Verpflichtungen oder Haftungen aus jeglichem Schaden aus, ganz gleich ob speziell, indirekt oder als Folge der Verwendung dieser Veröffentlichung oder des hierin beschriebenen Produkts bzw. in Zusammenhang mit der Verwendung dieser Veröffentlichung oder des hierin beschriebenen Produkts. Darüber hinaus wird das Recht vorbehalten, Änderungen an dieser Veröffentlichung vorzunehmen ohne die Verpflichtung, irgend jemanden über solche Änderungen zu unterrichten. Metrologic behält sich ferner das Recht vor, Änderungen an dem hierin beschriebenen Produkt vorzunehmen.

Esclusione della responsabilità

La Metrologic Instruments, Inc. e l'autore/gli autori non assumono nessuna garanzia e non rispondono della correttezza per quanto riguarda il contenuto o la precisione di quanto indicato nel presente Manuale o del prodotto in esso descritto. Neppure essi assumono una garanzia per l'idoneità o una garanzia della qualità media per un determinato scopo. Tutte le garanzie citate o fatte espressamente escludono qualsiasi obbligo o responsabilità derivanti da qualsiasi danno, indipendentemente dal fatto che questo obbligo/questa responsabilità risulti in particolare, indirettamente o come conseguenza dall'uso del presente Manuale o del prodotto in esso descritto oppure se è legato/a all'uso del presente Manuale o del prodotto in esso descritto. Inoltre ci si riserva il diritto di modificare il presente Manuale senza essere obbligati ad informare persona alcuna circa dette modifiche. Metrologic si riserva il diritto di apportare modifiche al prodotto descritto nel presente Manuale.

Appendix E

Notices

Notice

This equipment has been tested and found to comply with limits for a Class A digital device, pursuant to Part 15 of the FCC Rules. These limits are designed to provide reasonable protection against harmful interference when the equipment is operated in a commercial environment. This equipment generates, uses and can radiate radio frequency energy and, if not installed and used in accordance with the instruction manual, may cause harmful interference to radio communications. Operation of this equipment in a residential area is likely to cause harmful interference, in which case the user will be required to correct the interference at his own expense. Any unauthorized changes or modifications to this equipment could void the users authority to operate this device.

Notice

This digital apparatus does not exceed the Class A limits for radio noise emissions from digital apparatus set out in the Radio Interference Regulations of the Industry and Canada.

Caution

Use of controls or adjustments or performance of procedures other than those specified herein may result in hazardous laser light. Under no circumstances should the customer attempt to service the laser scanner. Never attempt to look at the laser beam, even if the scanner appears to be nonfunctional. Never open the scanner in an attempt to look into the device. Doing so could result in hazardous laser light exposure. The use of optical instruments with the laser equipment will increase eye hazard.

Remarque

Après contrôle de cet appareil, on a noté qu'il répondait aux valeurs limites de la classe A, conformément à la partie 15 des directives de l'administration fédérale américaine pour les télécommunications. Ces valeurs limites ont été prévues pour garantir une protection suffisante contre les effets nocifs dus à l'emploi de l'appareil dans un magasin. L'appareil génère et utilise une énergie haute fréquence et peut, s'il n'est pas installé et utilisé conformément aux instructions mentionnées dans le guide d'utilisation, entraîner des perturbations dans la radiocommunications. L'utilisation de cet appareil dans une zone d'habitation entraînera très vraisemblablement des perturbations. Dans ce cas, l'utilisateur est tenu de remédier à ces perturbations à ses propres frais. Toute modification ou remplacement non autorisé sur cet appareil peut entraîner l'invalidité de l'autorisation d'utilisation de l'appareil.

Remarque

Cet appareil numérique ne va pas contre les valeurs limites pour émissions de bruits radios des appareils numérique de la classe A, conformément aux directives relatives aux perturbations des radiocommunications du ministère canadien pour l'industrie.

Attention

L'emploi de commandes, réglages ou procédés autres que ceux décrits ici peut entraîner de graves irradiations. Le client ne doit en aucun cas essayer d'entretenir lui-même le scanner ou le laser. Ne regardez jamais directement le rayon laser, même si vous croyez que le scanner est inactif. N'ouvrez jamais le scanner pour regarder dans l'appareil. Ce faisant, vous vous exposez à une rayonnement laser mortel. L'emploi d'appareils optiques avec cet équipement laser augmente le risque d'endommagement de la vision.

Anmerkung

Nach Überprüfung dieses Geräts wurde festgestellt, daß es den Grenzwerten für Digitalgeräte der Klasse A gemäß Teil 15 der Richtlinien der US-amerikanischen Bundesbehörde für das Fernmeldewesen entspricht. Diese Grenzwerte wurden festgelegt, um einen angemessenen Schutz gegen schädliche Auswirkungen bei Einsatz des Geräts in einer Ladenumgebung zu gewähren. Das Gerät erzeugt und verwendet Hochfrequenzenergie und kann diese ausstrahlen, und kann, falls es nicht gemäß den im Bedienerhandbuch enthaltenen Anweisungen installiert und verwendet wird, zu einer Störung des Funkverkehrs führen. Der Betrieb dieses Geräts in einem Wohngebiet führt höchstwahrscheinlich zu Störungen. In diesem Fall ist der Bediener verpflichtet, die Störung auf eigene Kosten zu beseitigen. Durch jegliche unerlaubte Auswechslung oder Änderung an diesem Gerät könnte die Genehmigung des Bedieners zur Verwendung dieses Geräts ungültig werden.

Anmerkung

Dieses Digitalgerät verstößt nicht gegen die Grenzwerte für Funkrauschemissionen von Digitalgeräten der Klasse A gemäß den Richtlinien für Funkstörungen des kanadischen Ministeriums für Industrie.

Achtung

Die Verwendung anderer als der hierin beschriebenen Steuerungen, Einstellungen oder Verfahren kann eine lebensgefährliche Laserstrahlung hervorrufen. Der Kunde sollte unter keinen Umständen versuchen, den Laser-Scanner selbst zu warten. Sehen Sie niemals in den Laserstrahl, selbst wenn Sie glauben, daß der Scanner nicht aktiv ist. Öffnen Sie niemals den Scanner, um in das Gerät hineinzusehen. Wenn Sie dies tun, können Sie sich einer lebensgefährlichen Laserstrahlung aussetzen. Der Einsatz optischer Geräte mit dieser Laserausrüstung erhöht das Risiko einer Sehschädigung.

N.B.

Dal controllo di questo apparecchio risulta che esso risponde ai valori limite per apparecchi digitali della classe A conf. parte 15 delle direttive sulle telecomunicazioni dell'Autorità federale statunitense. Questi valori limite sono stati fissati per garantire una protezione adeguata contro gli effetti nocivi se questo apparecchio viene usato all'intero di un negozio. L'apparecchio genera, utilizza e può emettere energia ad alta frequenza e, se non viene installato ed utilizzato conformemente alle indicazioni fornite nel Manuale utente, può provocare disturbi al servizio radiofonico. L'uso di questo apparecchio in zone residenziali causa molto probabilmente dei disturbi. In questo caso l'utente è obbligato ad eliminare questi disturbi a sue spese. Qualsiasi sostituzione o modifica non autorizzata all'apparecchio potrebbe rendere invalida l'autorizzazione dell'utente all'uso dell'apparecchio.

N.B.

Questo apparecchio digitale non supera I valori limite per l'emissione di radiorumori da parte di apparecchi digitali della classe A conformemente alle direttive per radiodisturbi del Ministero canadese per l'Industria.

Attenzione

L'utilizzo di sistemi di controllo, di regolazioni o di procedimenti diversi da quelli decritti nel presente Manuale può provocare dei raggi laser pericolosi per la vita. Il cliente non deve assolutamente tentare di riparare egli stesso lo scanner laser. Non guardate mai nel raggio laser, anche se credete che lo scanner non sia attivo. Non aprite mai lo scanner per guardare dentro l'apparecchio. Se tuttavia lo fate, potete esporVi a dei raggi laser pericolosi per la vita. L'uso di apparecchi ottici con questo equipaggiamento laser aumenta il rischio di danni alla vista.

Appendix F

Patents

“Patent Information

This METROLOGIC product may be covered by one or more of the following U.S. Patents:

U.S. Patent No. 4,360,798; 4,369,361; 4,387,297; 4,460,120; 4,496,831; 4,593,186; 4,607,156; 4,673,805; 4,736,095; 4,758,717; 4,816,660; 4,845,350; 4,896,026; 4,923,281; 4,933,538; 4,992,717; 5,015,833; 5,017,765; 5,059,779; 5,117,098; 5,124,539; 5,130,520; 5,132,525; 5,140,144; 5,149,950; 5,180,904; 5,200,599; 5,229,591; 5,247,162; 5,250,790; 5,250,791; 5,250,792; 5,262,628; 5,280,162; 5,280,164; 5,304,788; 5,321,246; 5,324,924; 5,396,053; 5,396,055; 5,408,081; 5,410,139; 5,436,440; 5,449,891; 5,468,949; 5,479,000; 5,532,469; 5,545,889

No license right or sublicense is granted, either expressly or by implication, estoppel, or otherwise, under any METROLOGIC or third party intellectual property rights (whether or not such third party rights are licensed to METROLOGIC), including any third party patent listed above, except for an implied license only for the normal intended use of the specific equipment, circuits, and devices represented by or contained in the METROLOGIC products that are physically transferred to the user, and only to the extent of METROLOGIC’s license rights and subject to any conditions, covenants and restrictions therein.”

Volume Control Card

IMPORTANT!
KEEP THIS CARD WITH THE SCANNER

Scan for Softer Volume



SCAN FOR SOFTER VOLUME. SAVE THIS CARD.
LEES CODE VOOR STILLER VOLUME. KAART BIJHOUDEN.
DIESER CODE VERRINGERT DIE LAUTSTÄRKE. BITTE KARATE AUFHEBEN.
LIRE CE CODE POUR BAISSER LE VOLUME. CONSERVER CETTE CARTE.
LEER CONDIGO PARA BAJAR VOLUME. GUARDAR ESTA CARTA.
QUESTO CODICE DIMINUISCE IL VOLUME. CONSERVATE LA CARTA.
LER O CÓDIGO PARA VOLUME MAIS BAIXO. GUARDAR ESTE CARTÃO.
ПРОСКАНИРУЙТЕ ЭТОТ КОД ДЛЯ ЦОНИЖЕНИЯ
ГРМКОСТИ. СОХРАНИТЕ ЭТУ КАРТОЧКУ.

扫描低音 保留卡片

音量減少にはこのカードをスキヤンして
下さい。

Metrologic[®]

USA Corporate Headquarters

Metrologic Instruments, Inc.
Blackwood, NJ 08012
Customer Service: 1-800-ID-METRO
Tel: 609-228-8100
Fax: 609-228-6673

South America

Metrologic Instruments
CEP 04571-090, São Paulo-SP, Brasil
Outside Brazil:
Tel: 55-11-5505-6568
Fax: 55-11-5505-1681
In Brazil:
Tel: 55-11-5505-2396
Fax: 55-11-5507-2301

Europe

Metrologic Instruments GmbH
Munich, Germany
Tel: 49-89-89018-0
Fax: 49-89-89019-200

ASIA

Metrologic Asia (PTE) Ltd.
Singapore 417818
Tel: 65-842-7155
Fax: 65-842-7166

IMPORTANT!

KEEP THIS CARD WITH THE SCANNER

Scan for Louder Volume



SCAN FOR LOUDER VOLUME. SAVE THIS CARD.
LEES CODE VOOR LUIDER VOLUME. KAART BIJHOUDEN.
DIESER CODE ERHÖHT DIE LAUTSTÄRKE. BITTE KARTE AUFHEBEN.
LIRE CE CODE POUR AUGMENTER LE VOLUME. CONSERVER CETTE CARTE.
LEER CODIGO PARA AUMENTAR VOLUME. GUARDAR ESTA CARTA.
QUESTO CODICE AUMENTA IL VOLUME. CONSERVATE LA CARTA.
LER O CÓDIGO PARA VOLUME MAIS ALTO. GUARDAR ESTE CARTÃO.
ПРОСКАНИРУЙТЕ ЭТОТ КОД ДЛЯ ЦЕЛЫЦЕНИЯ
ГРМКОСТИ. СОХРАНИТЕ ЭТУ КАРТОЧКУ.

扫描高音 保留卡片

音量増大にはこのカードをスキヤンして
下さい。

MetrologiC

USA Corporate Headquarters

MetrologiC Instruments, Inc.
Blackwood, NJ 08012
Customer Service: 1-800-ID-METRO
Tel: 609-228-8100
Fax: 609-228-6673

South America

MetrologiC Instruments
CEP 04571-090, São Paulo-SP, Brasil
Outside Brazil:
Tel: 55-11-5505-6568
Fax: 55-11-5505-1681
In Brazil:
Tel: 55-11-5505-2396
Fax: 55-11-5507-2301

Europe

MetrologiC Instruments GmbH
Munich, Germany
Tel: 49-89-89018-0
Fax: 49-89-89019-200

ASIA

MetrologiC Asia (PTE) Ltd.
Singapore 417818
Tel: 65-842-7155
Fax: 65-842-7166

MLPN 2346 - REV 9/98

Index

A

- AC input/outlet 3, 10
- Adaptor 7, 10
 - cable 6, 39
- Application 26
- Application and protocols 25
- Asia ii
- Assignments
 - pin 36-41
- Attaching stand 12

B

- Bar codes 1, 4, 5, 9, 13, 14, 16, 20
- Beep 3, 4, 10, 16, 19
- Beeper operation 27
- Base 12

C

- Cable
 - adaptor 6, 39
 - cloning 5
 - communication 2, 3, 9, 10, 13, 36-41
- CDRH class IIa 21, 26
- Class 1 26
- Clean 25, 27
- Communication protocol 25
- Communications buffer 6
- Communications bus 6
- Compliance 3, 10
- Configuration 4, 6-8, 28, 39
- Contrast 27
- Copyright ii
- Current 26
- Customer Service ii, 42

D

- DC transformer 26
- Decode capability 27
- Default settings 28-35

- Depth of field 22-24, 27
- Dimensions 26
- Disclaimer 43

E

- Electrical 26
- Email ii
- Environmental 27
- ESD 27
- Europe ii
- External Power supply 6

F

- Failure indicator 16
- Faulty equipment 42
- Fax ii
- Functions 28-41

G

- Germany (GmbH) ii, 42
- Good read 27
- Green LED 3, 10, 13, 14, 16

H

- Headquarters ii
- Host 3, 4, 28, 36-38, 40, 41
- Humidity 27

I

- Indicators
 - LED 3, 10, 13, 14, 16-19, 27
 - Visual 16-19
- Interfaces 25, 27
- Installation 11
- Internet ii
- Introduction 1

K

- Keyboard Wedge 9, 10, 25, 27, 39

L

Labels 21
 LASERKLASSE 1 21
 LEDs 3, 10, 13, 14, 16-19, 27
 Light levels 27
 Light pen emulation 1, 9, 25,
 27, 36, 39
 Light source 26
 Limited warranty 42
 List 2
 Locations ii

M

Maintenance 25, 27
 MECCA 1
 Mechanical 26
 Model number 21, 25

N

Notices 44, 45

O

OCIA 1, 25, 27, 36, 37
 Operating current 26
 Operating temperature 27
 Operation 4, 14
 Operational 27
 Orientation 26
 Output format 6
 Output window 25

P

Parts 13
 Patents 46
 PC 1, 9, 10, 39
 Pin assignments 36-41
 Port(s) 6-8
 Power consumption 26
 Power supply 2, 6, 26
 Print contrast 27
 Programming guide 1, 2, 4,
 9, 14, 20, 28, 39
 Protocols 25

R

Red LED 13, 16, 27
 Repair 42
 Rights
 property 46
 warranty 42
 RMA 42
 Roll, pitch, yaw 27
 RS-232 1, 4, 9, 25, 27, 36, 38, 39
 RS-422 25, 27, 40, 41
 RS-485 25, 38

S

Scan field(s) 22, 27
 Scan lines 27
 Scan pattern 22, 27
 Scanner connections 3, 4
 ScanSet 1, 4, 7, 9, 14-20, 39
 ScanSelect manual 1, 2, 4,
 7, 9, 14, 15, 20, 28, 39
 Scan speed 27
 Service 42
 Shipping carton 2
 Socket-outlet 3
 South America ii
 Specifications 26, 27
 Stand 2, 12
 Storage temperature 27
 System interfaces 27

T

Temperature 27
 Tones 27
 Top cover 13, 26
 Transformer 3, 5, 10, 16, 26,
 36-41

U

UL/CSA/TUV 26
 USA corporate headquarters
 ii

V

Ventilation 27

Version identifiers	25
Vertical stand	2, 12
Voltage	3, 10, 27
Volume control card	47, 48

W

Warranty	42
Watt(s)	26
Weight	26
Window	1, 13, 21, 22, 25-27