

CipherLab Reference Manual

RS50 Mobile Computer
Android™ 6.0, Marshmallow

Version 1.01



Copyright © 2017 CIPHERLAB CO., LTD.
All rights reserved

The software contains proprietary information of its owner; it is provided under a license agreement containing restrictions on use and disclosure and is also protected by copyright law. Reverse engineering of the software is prohibited.

Due to continued product development, this information may change without notice. The information and intellectual property contained herein is confidential between the owner and the client and remains the exclusive property of the owner. If having any problems in the documentation, please report them to us in writing. The owner does not warrant that this document is error-free.

No part of this publication may be reproduced, stored in a retrieval system, or transmitted in any form or by any means, electronic, mechanical, photocopying, recording or otherwise without the prior written permission of the owner.

For product consultancy and technical support, please contact the local sales representative. Also, visit our website for more information.

All brand, logo, product and service, and trademark names are the property of their registered owners.

Google, Google Play, Android and other marks are trademarks of Google Inc.

The editorial use of these names is for identification as well as to the benefit of the owners, with no intention of infringement.

CIPHERLAB logo is a registered trademark of CIPHERLAB CO., LTD.. All other brands, products and services, and trademark names are the property of their registered owners. The editorial use of these names is for identification as well as to the benefit of the owners, with no intention of infringement.

CIPHERLAB CO., LTD.
Website: <http://www.CipherLab.com>

IMPORTANT NOTICES

FOR USA

FCC ID: Q3N-RS50

This equipment has been tested and found to comply with the limits for a **Class B** digital device, pursuant to Part 15 of the FCC Rules. These limits are designed to provide reasonable protection against harmful interference in a residential installation. This equipment generates, uses and can radiate radio frequency energy and, if not installed and used in accordance with the instructions, may cause harmful interference to radio communication. However, there is no guarantee that interference will not occur in a particular installation. If this equipment does cause harmful interference to radio or television reception, which can be determined by turning the equipment off and on, the user is encouraged to try to correct the interference by one or more of the following measures:

- ▶ Reorient or relocate the receiving antenna.
- ▶ Increase the separation between the equipment and receiver.
- ▶ Connect the equipment into an outlet on a circuit different from that to which the receiver is connected.
- ▶ Consult the dealer or an experienced radio/TV technician for help.

This device complies with Part 15 of the FCC Rules. Operation is subject to the following two conditions: (1) This device may not cause harmful interference, and (2) this device must accept any interference received, including interference that may cause undesired operation.

FCC Caution:

Any changes or modifications not expressly approved by the party responsible for compliance could void the user's authority to operate this equipment.

This transmitter must not be co-located or operating in conjunction with any other antenna or transmitter.

Find the certificate information from:

Setup → About Phone → Regulatory information



Tested to Comply with FCC Standards

FOR HOME OR OFFICE USE

FOR PRODUCT WITH LASER

- ▶ This laser component emits FDA / IEC Class 2 laser light at the exit port. Do NOT STARE INTO BEAM DIRECTLY.
- ▶ Do not aim the beam at the eyes.
- ▶ Any adjustments or performance excluding those specified herein may result in hazardous laser light exposure.



ENVIRONMENT

- ▶ Operate the mobile computer at ambient temperatures from -20°C to 50°C and with humidity range from 10% to 90%.
- ▶ Store the device at ambient temperatures from -30°C to 70°C and with humidity range from 5% to 95%.
- ▶ Charge the device at ambient temperatures from 0°C to 35°C.
- ▶ This device is built with a dust-proof and splash-proof structure that conforms to protection class IP67.

SPECIFIC ABSORPTION RATE (SAR) INFORMATION

The product complies with the FCC / Canada portable RF exposure limit set forth for an uncontrolled environment and are safe for intended operation as described in this manual. The further RF exposure reduction can be achieved if the products can be kept as far as possible from the user body or set the device to lower output power if such function is available.

The SAR test distance is Head (0 mm), Body (10 mm) and Hotspot (10 mm).

For body-worn operating conditions please use belt-clips, holsters, and/or accessories that have no metallic component in the assembly and must provide at least 10mm separation between the device and the user's body.

- ▶ FCC SAR Value (Standard limit is 1.6 W/Kg)
- ▶ USA (1g): Max. 1.54 W/Kg

A minimum separation distance of 0.5 cm must be maintained between the user's body and the device, including the antenna during body-worn operation to comply with the RF exposure requirements in Europe.

To compliance with RF Exposure requirements in Europe, third-party belt-clips, holsters or similar accessories used by this device should not contain any metallic components. The use of accessories that do not satisfy these requirements may not comply with RF exposure requirements, and should be avoided.

- ▶ CE SAR Value (Standard limit is 2 W/Kg)
- ▶ EU (10g): Max. 1.6 W/Kg

SAFETY PRECAUTIONS



Warning statement:

A pleine puissance, l'écoute prolongée du baladeur peut endommager l'oreille de l'utilisateur.

To prevent possible hearing damage, do not listen at high volume levels for long periods.

- ▶ For people's safety
- ▶ Do not listen at high volume levels for long periods to prevent possible hearing damage.
- ▶ Do not operate this device while walking, cycling or car driving.
- ▶ For the equipment
- ▶ Do not use any batteries or charging devices which are not originally sold or manufactured by CIPHERLAB CO., LTD.
- ▶ Do not replace the battery with an incorrect type, to avoid the risk of heat generation, fire, or explosion.
- ▶ Do not disassemble, incinerate or short circuit the battery.
- ▶ Do not touch the contact pins of the battery pack.
- ▶ Do not expose the mobile computer or battery to any flammable sources.
- ▶ Do not expose the mobile computer to extreme temperatures or soak it in water.
- ▶ Do not use any pointed or sharp objects against the screen surface.
- ▶ Do not use the styluses which are not supplied or approved by CIPHERLAB CO., LTD., to prevent possible scratches to the touch screen.
- ▶ Water residue on the touch screen may cause abnormal behaviors or the fall of its sensitivity levels.
- ▶ On the surface of the terminal and the barcode reading window, the fog or water drops caused by low temperatures may influence barcode reading.
- ▶ Do not use bleaches or cleaners to clean the device. Use a clean, wet cloth instead.

BATTERY

- ▶ Risk of explosion if battery is replaced by an incorrect type. Dispose of used batteries according to the instructions.
- ▶ The main battery may not be charged to full for shipment. Charge the main battery to full before using the mobile computer for the first time.
- ▶ Main battery: The main battery powers the mobile computer to work. It takes approximately 4 hours to charge an empty main battery to full. The charging LED above the screen will light up in red while charging and will turn green when charging is complete.
- ▶ When the main battery is removed, RTC retention will be maintained for at least 30 minutes.
- ▶ Backup battery: The backup battery is mounted on the main board. Its role is to temporarily keep the mobile computer in suspension when the main battery is drained out so data in DRAM will be retained. The backup battery takes approximately 3.5 hours to charge to full by the main battery or power adapter.
- ▶ It is recommended to charge the battery at room temperature (18°C to 25°C) for optimal performance.
- ▶ Battery charging stops when ambient temperature drops below 0°C or exceeds 35°C.

- ▶ In order to prevent system from shutting down after the battery is drained out, keep a fresh battery for replacement at all times, or connect the mobile computer to an external power.
- ▶ If there are drippings or dust on the device or battery pack, wipe them away with a soft clean cloth before battery replacement.
- ▶ Turn off the power before battery replacement.
- ▶ If you want to put away the mobile computer for a period of time, remove the battery pack from the mobile computer's battery compartment. Store the mobile computer and battery pack separately.
- ▶ Recycle batteries in a proper way for the green-environment issue.

SCANNER

- ▶ Scan a 1D barcode
 - 1) Open **ReaderConfig** and tap **Scan Test** on the menu bar.
 - 2) Aim the scanning window at the barcode to read. Move the device, having the barcode located in the center of the scanning area.
 - 3) Press any of the two side triggers. The scanning light beams to read the printed barcodes. The buzzer beeps after scanning. The scanning light goes off once the data is decoded, or when the decode timeout period has passed.
- ▶ Scan a 2D barcode
 - 1) Open **ReaderConfig** and tap **Scan Test** on the menu bar.
 - 2) Aim the scanning window at the barcode to read. Move the device, having the barcode located in the center of the scanning area.
 - 3) Press any of the two side triggers. The scanning light beams to read the printed barcodes. The buzzer beeps after scanning. The scanning light goes off once the data is decoded, or when the decode timeout period has passed. USA and Canada e-label

CONNECTION

- ▶ Via Bluetooth or WLAN
- ▶ Connection may fail when the mobile computer is around other wireless machines or power cables as the radio frequencies of those may cause interferences.
- ▶ If communication fails, move the devices much closer to each other, and try to communicate again
- ▶ After turning on, Bluetooth power is sustained even when the mobile computer is suspended. However, if the power mode is switched to Airplane Mode, Bluetooth power will be turned off regardless of the settings.
- ▶ To a charging cradle
- ▶ Do not insert the mobile computer to a charging cradle if water or drippings are staying on the device.
- ▶ The LED indicator on a charging cradle shows the status of battery charging only; the status of terminal charging is shown on the device itself.
- ▶ Not Charging could be the result of battery damage, battery's failure to touch the connector or AC plug coming off.
- ▶ Charging error could be due to high battery temperature.

CARE & MAINTENANCE

- ▶ This mobile computer is intended for industrial use. The mobile computer is rated IP67, however, damage may be done to the mobile computer if it is exposed to extreme temperatures or soaked in water.
- ▶ When the body of the mobile computer gets dirty, use a clean, wet cloth to wipe off dust and debris. DO NOT use bleaches or cleaners.
- ▶ Use a clean, non-abrasive, lint-free cloth to wipe dust off the LCD touch screen. DO NOT use any pointed or sharp objects against the surface. Always keep the LCD dry.
- ▶ If you want to put away the mobile computer for a period of time, download the collected data to a host computer, and then remove the battery pack from the mobile computer's battery compartment. Store the mobile computer and battery pack separately.
- ▶ If you encounter malfunction on the mobile computer, write down the specific scenario and consult your local sales representative.

E-LABEL

Mobile Computer
Model : RS50

US

FCC ID : Q3N-RS50



This device complies with Part 15 of the FCC Rules.
Operation is subject to the following two conditions:
(1) This device may not cause harmful interference, and
(2) this device must accept any interference received,
including interference that may cause undesired operation.

TW



減少電磁波影響,請妥適使用

EUROPE - EU DECLARATION OF CONFORMITY



Manufacturer

CIPHERLAB Co., Ltd.
 12F., 333, Dunhua S. Rd., Sec. 2
 Taipei, Taiwan 106, R.O.C.
 Tel: +886 2 8647 1166
<http://www.cipherlab.com>

CipherLab Europe
 Flight Forum 40,
 5657 DB Eindhoven, The Netherlands
 Tel: +31 (0) 40 295 1510
<http://www.cipherlab.eu>

Type of Equipment

Mobile Computer

Model(s) Declared

RS50

Initial Year of Manufacture **2017**

CE issued date **2017**

Reference to the specification under which conformity is declared in accordance with Council Directive- 2014/30/EU(EMC), 2014/35/EU(LVD), 2011/65/EU (RoHS), 1999/519/EC (EMF), 2014/53/EU (RED).

- | | |
|---------------------------------|----------------------------|
| EN 300 328 V2.1.1 | EN 300 330 V2.1.1 |
| EN 301 511 V9.0.2 | EN 50566:2013 AC:2014 |
| EN 301 908-2 V11.1.1 | Draft EN 303 413 V1.1.0 |
| EN 301 908-13 V11.1.1 | EN 301 908-1 V11.1.1 |
| EN 50360 :2001 A1:2012 | EN 62479:2010 |
| EN 55024 : 2010+A1:2015 | EN55032 : 2015+AC:2016 |
| EN 60950-1 : 2006+A2:2013 | EN 61000-3-2 :2014 |
| EN 301 489-1 V2.1.1 | EN 61000-3-3 :2013 |
| Final Draft EN 301 489-3 V2.1.1 | EN 301 893 V2.1.1 |
| EN 301 489-17 V3.1.1 | Draft EN301 489-52 V1.1.0 |
| | Draft EN 301 489-19 V2.1.0 |

I the undersigned, hereby declare that the equipment specified above conforms to the above Directive(s) and Standard(s).

Manufacture Signature

Full Name :Herbie Jiang

Title : Manager

Date: 2017.06.14

RELEASE NOTES

Version	Date	Notes
1.02	Jun. 26, 2017	Modified:
1.01	Jun. 19, 2017	Modified: 2.1.3 – note for system time reset added
1.00	Jun. 07, 2017	Initial release

CONTENTS

IMPORTANT NOTICES.....	- 3 -
For USA	- 3 -
For Product with Laser	- 4 -
Environment	- 4 -
Specific Absorption Rate (SAR) information	- 4 -
Safety Precautions	- 5 -
Battery.....	- 5 -
Scanner.....	- 6 -
Connection.....	- 7 -
Care & Maintenance	- 7 -
e-label	- 8 -
EUROPE - EU Declaration of Conformity	- 9 -
RELEASE NOTES	- 10 -
CONTENTS	11
INTRODUCTION	14
Features.....	15
Inside the Package.....	15
Accessories.....	15
Related Documentation.....	15
QUICK START	16
1.1. Overview	17
1.1.1. Installing Battery.....	19
1.1.2. Installing SIM Card, SAM Card and Memory Card	21
1.1.3. Power On/Off Mobile Computer	23
1.1.4. Homescreen Selection	24
1.1.5. Using Hardware Buttons	25
1.1.6. Connecting Headset.....	25
1.2. Charging & Communication	26
1.2.1. Charge Mobile Computer	26
1.2.2. Wired Data Transmission.....	30
1.2.3. Using Wireless Networks.....	31
USING THE RS50 MOBILE COMPUTER.....	32
2.1. Battery	33
2.1.1. Battery Status Indicators.....	34
2.1.2. Monitor Battery Level	36
2.1.3. Replace Main Battery.....	40
2.1.4. Power Management	41
2.2. Memory	42
2.2.1. Check Memory Usage.....	43

2.2.2.	Manage Storage Space.....	44
2.3.	Touch Screen.....	51
2.3.1.	Screen Brightness.....	51
2.3.2.	Screen rotation.....	52
2.3.3.	Screen Timeout Settings.....	54
2.3.4.	Text Size.....	55
2.4.	Notifications.....	56
2.4.1.	Status LED.....	56
2.4.2.	Audio.....	57
2.4.3.	Sounds and Vibration.....	58
2.5.	Date and Time.....	60
2.5.1.	Set Date, Time and Time Zone.....	60
2.6.	Language & Keyboard Input.....	62
2.6.1.	Change Display Language.....	62
2.6.2.	On-screen Keyboard.....	63
2.7.	Sound and Volume.....	70
2.8.	Programmable Keys.....	71
2.9.	Data Capture.....	77
2.9.1.	Barcode Reader.....	77
2.9.2.	Digital Camera.....	77
BASIC OPERATION.....		78
3.1.	Home Screen.....	79
3.1.1.	Customize Home Screen.....	81
3.2.	Status Bar.....	88
3.2.1.	Icons on Status Bar.....	88
3.2.2.	Open Quick Setting Menu.....	90
3.2.3.	Open Notifications Drawer.....	91
3.3.	Manage Applications.....	93
3.3.1.	Application Menu.....	93
3.3.2.	Current Applications.....	95
3.4.	Suspend & Lock.....	96
3.4.1.	Suspend Device.....	96
3.4.2.	Lock Device.....	96
3.5.	OS Update.....	98
3.6.	Back up Your Data.....	100
3.7.	Reset to Factory Default.....	101
WIRELESS RADIOS.....		103
4.1.	Use Wireless Wide Area Network.....	104
4.1.1.	Share WWAN Data.....	106
4.1.2.	Data Connection Settings.....	111
4.1.3.	SIM Card Settings.....	112
4.2.	Use Wireless Local Area Network (Wi-Fi).....	113
4.2.1.	Connect to Wi-Fi Network.....	113
4.2.2.	Manually Add Wi-Fi Network.....	114
4.2.3.	Advanced Wi-Fi Settings.....	115
4.2.4.	Configure Proxy Server.....	116
4.2.5.	Use Static IP Address.....	116
4.2.6.	Connect With Wi-Fi Protected Setup (WPS).....	116

4.2.7.	Modify Wi-Fi Network.....	117
4.2.8.	Disconnect Wi-Fi Network	117
4.3.	Use Bluetooth	118
4.3.1.	Bluetooth Profiles	118
4.3.2.	Turn On Bluetooth	119
4.3.3.	Change Bluetooth Name.....	120
4.3.4.	Pair Bluetooth Devices.....	121
4.3.5.	Unpair Bluetooth Device	121
4.4.	Use Near Field Communications	122
USING THE PHONE.....		124
5.1.	SIM Card Management	125
5.2.	Phone Application.....	126
5.2.1.	Phone Interface	126
5.2.2.	Place Call.....	127
5.2.3.	During A Call.....	128
5.2.4.	Receive Incoming Call	130
5.2.5.	Check Missed Calls	131
5.2.6.	Call History	132
5.2.7.	Make Multi-Party Calls.....	133
5.3.	Audio Modes	134
5.4.	In-call Volume	134
USING READER CONFIGURATION UTILITY		135
6.1.	Configuring Reader.....	136
6.1.1.	General Settings	137
6.1.2.	Symbology	144
6.1.3.	Miscellaneous.....	147
6.1.4.	Reader Config Option Menu.....	148
6.2.	Read Printed Barcodes	155
SPECIFICATIONS		157
Platform, Processor & Memory.....		157
Communication & Data Capture		158
Electrical Characteristics		159
Physical Characteristics.....		159
Environmental Characteristics		160
Programming Support.....		161
APPENDIX I.....		162
Scan Engine Settings		162
Symbologies Supported.....		162
APPENDIX II.....		164
2D Imager.....		164
Symbology Settings.....		164
APPENDIX III.....		175
Open Source License		175

INTRODUCTION

The **RS50** mobile computer, powered by Android™ 6.0 Marshmallow, is light-weight, easy to use, providing powerful and handy tools for the purpose of delivering flexibility in customization.

Specifically designed to work as an industrial PDA, it provides rich options of data collection, voice and data communication, long-lasting working hours, and so on. Its large color capacitive display guarantees ease in reading in all lighting conditions. Integrated with Bluetooth v4.1, v2.1+EDR, 802.11a/b/g/n/ac technologies, the mobile computer also includes a GSM/GPRS/EDGE/WCDMA/HSPA/HSPA+/LTE CAT 6 module to gain greater speeds and optimal mobility. In particular, an integrated GPS receiver is made available for use with third-party location-based applications.

This manual serves to guide you through how to install, configure, and operate the mobile computer. The [Care & Maintenance](#) section is specifically crucial for those who are in charge of taking care of the mobile computer.

We recommend you to keep one copy of the manual at hand for quick reference or maintenance purposes. To avoid any improper disposal or operation, please read the manual thoroughly before use.

FEATURES

- ▶ Built tough to survive drop test and sealed against moisture/dust to industrial standard IP65/IP67.
- ▶ Android™ 6.0 Marshmallow operating system with a powerful Cortex 1.3 GHz Quad-Core processor
- ▶ 16GB eMMC flash memory to store OS and software programs
- ▶ 2GB LPDDR3 SDRAM to store and run programs, as well as store program data
- ▶ One expansion slot for microSDHC card up to 32GB and microSDXC card up to 2TB.
- ▶ Built-in 8.0 Megapixel rear camera with white LED for flash and auto focus.
- ▶ One side trigger for scanning
- ▶ Total wireless solution — connectivity includes Bluetooth v4.1 and v2.1+EDR, 802.11 a/b/g/n/ac, GSM/GPRS/EDGE/WCDMA/HSPA/HSPA+/LTE CAT6.
- ▶ A 4.7" color transmissive display with 720x1280 pixels to deliver excellent visibility in all lighting conditions
- ▶ Configurable feedback indicators including speaker and vibrator
- ▶ Built-in scan engine setting tool Reader Configuration which serves out-of-the-box keyboard wedge functionality
- ▶ Accessories and peripherals include Snap-on Charging Cable and Charging Cradle (both are capable of USB Charging and Data Transfer)

INSIDE THE PACKAGE

The following items are included in the kit package. Save the box and packaging material for future use in case you need to store or ship the mobile computer.

- ▶ RS50 Mobile Computer
- ▶ Rechargeable Li-ion battery pack
- ▶ Hand Strap
- ▶ Micro USB Charging and Data Transfer Cable
- ▶ Snap-on Charging Cable
- ▶ AC Power Adaptor
- ▶ Quick Start Guide

ACCESSORIES

- ▶ Handbelt
- ▶ Charging cradle

RELATED DOCUMENTATION

Log in to **GoBetween** to access related documentation about the RS50 mobile computer from the CipherLab Central Service (CCS) platform. Download the **GoBetween desktop** or mobile device application, or launch the GoBetween Lite web application from the following site: <http://ccs.cipherlab.com/>.

Chapter 1

QUICK START

This chapter helps you get ready for starting using the mobile computer.

IN THIS CHAPTER

- 1.1 Overview 17
- 1.2 Charging & Communication 26

1.1. OVERVIEW

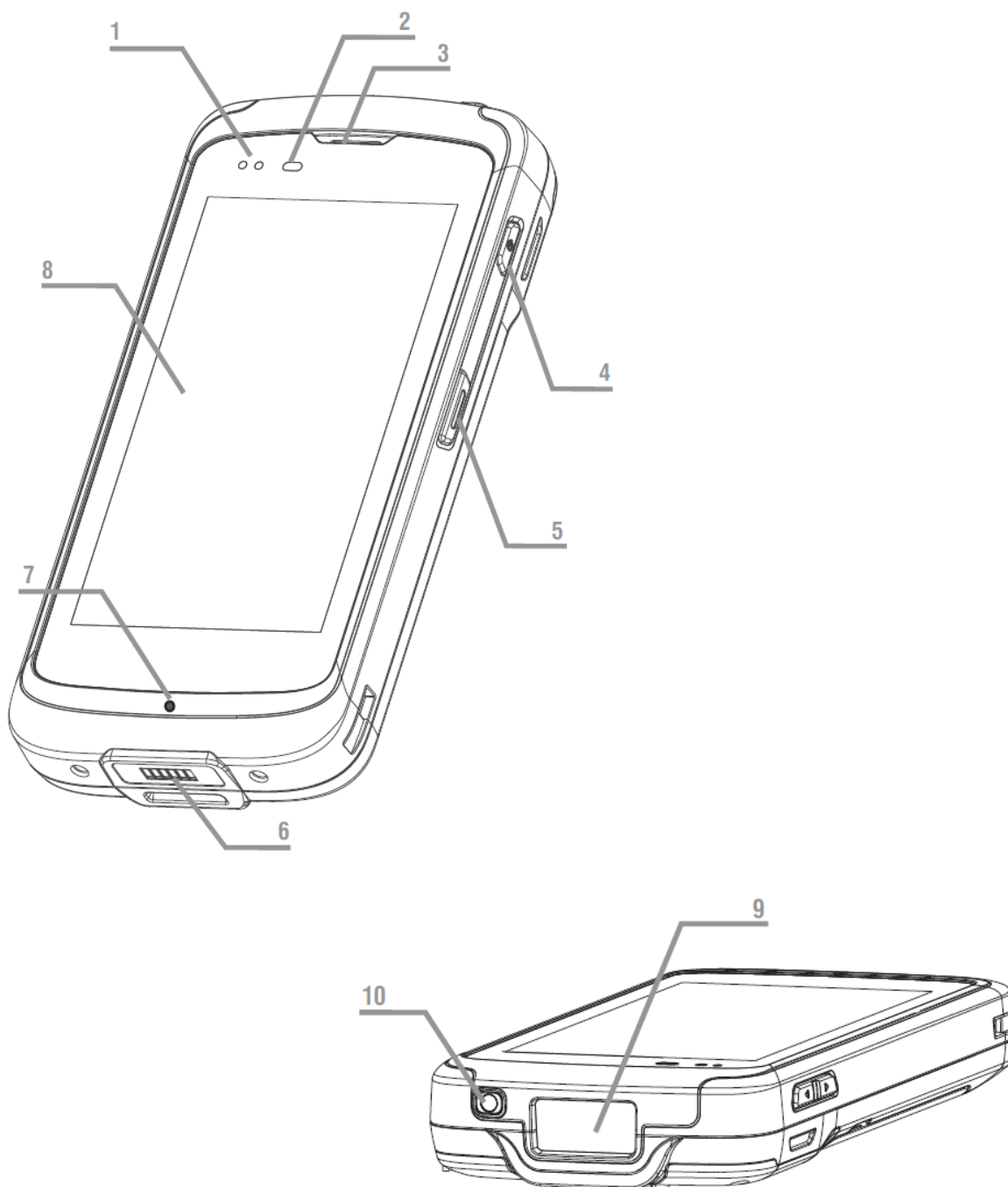

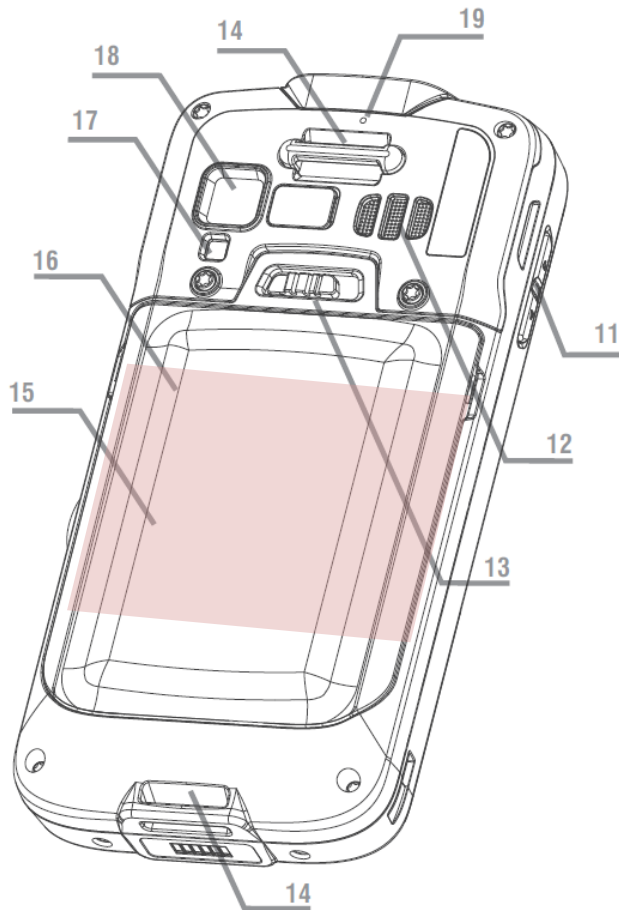

No.	Description	No.	Description
1	Status LED	2	Proximity+ALS Sensor
3	Phone Receiver	4	Power Button
5	Side Trigger Key	6	Charging & Communication Pins
7	Microphone	8	Touchscreen
9	Scan Window	10	Headset Jack
11	Volume Buttons	12	Loudspeaker
13	Battery Latch	14	Wrist Band Hole
15	NFC Detection Area	16	Battery
17	Camera Flash	18	Camera Lens
19	Rear Microphone		

1.1.1. INSTALLING BATTERY

For shipping and storage purposes, the mobile computer and the main battery are saved in separate packages.

Note:

Any improper handling may reduce the battery life.

To install the main battery:

- 1) Insert the main battery with the contact pins facing the lower end. Fix the lower edge of the battery first.
- 2) Then push down the upper end. The battery latch will fit into place with a click sound.

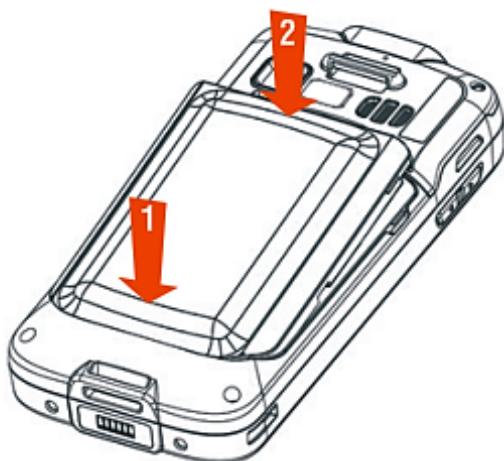

IMPORTANT CHARGING INFORMATION

Power Adaptor	Input: AC 100-240V, 50-60Hz; output: 5V/2A CipherLab approved
Battery Pack (Optional)	3.8V 4000mAH/3.8V 5300mAH (Standard/Extended) rechargeable Li-ion CipherLab proprietary
Charging time	Approx. 5 hours/6 hours (Standard/Extended battery) via adapter

Warning:

For initial use, insert a charged battery, and then press the Power key to power on the mobile computer.

REMOVE BATTERY

- 1) Shut down this device first.
- 2) Slide the key latch right; the battery will be unlocked with a click sound.
- 3) Lift the battery up from its upper end.

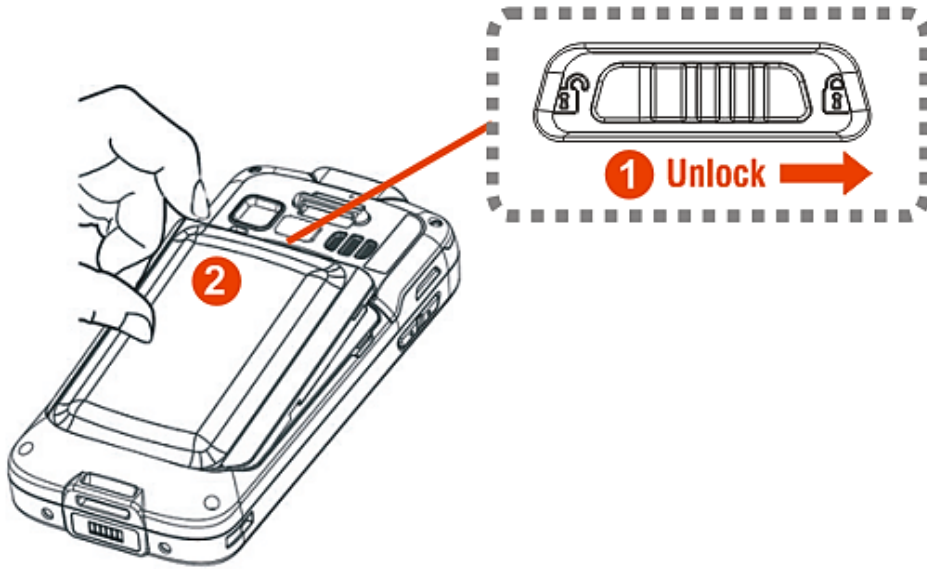

1.1.2. INSTALLING SIM CARD, SAM CARD AND MEMORY CARD

The RS50 mobile computer is equipped with two SIM card slots, one SAM card slot and one memory card slot.

To insert the cards:

- 1) Remove the battery as described in Remove Battery.
- 2) Insert your fingernail into the notch above the inner lid that protects the card sockets chamber, and lift it up.

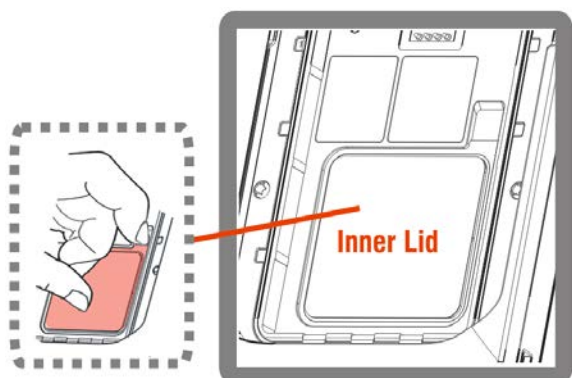

- 3) After the chamber is revealed, insert SIM cards, the SAM card and the microSD card into their respective sockets. Close and push back the hinged cover till a click sounds.

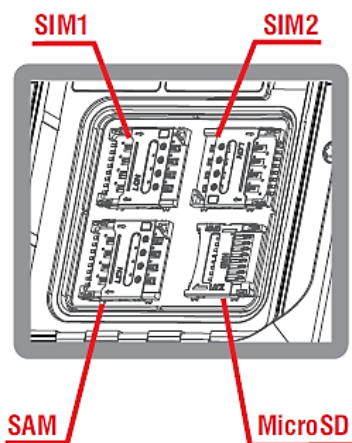

- To install the cards:
- 1) Slide the hinged cover back.
 - 2) Swing the top open, and then insert the card.
 - 3) Close the hinged cover, and then push it back.

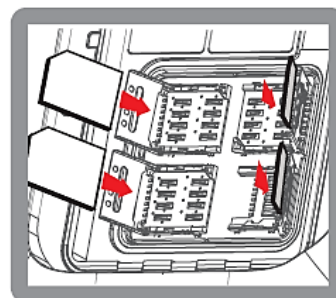
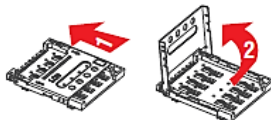

- 4) Replace the inner lid.
- 5) Replace the battery.

Note:

Both SIM1 and SIM2 card slots support 2G/3G/4G cards. However, you can have 3G/4G data transmission on either SIM but not on both at the same time. Refer to [SIM Card Management](#) for details on managing dual SIM cards.

REMOVE CARDS

- 1) Remove the battery.
- 2) Remove the inner lid.
- 3) Unlock the card hinge cover and remove the card.
- 4) Replace the inner lid and the battery.

1.1.3. POWER ON/OFF MOBILE COMPUTER

POWER ON

To power on the mobile computer, press and hold the power button  located on the upper right side of the device. The mobile computer will turn on and show the [Home Screen](#) after splash screen.

Note:

For the mobile computer to power on, the battery cover must be secured in place.

POWER OFF

To power off the mobile computer, press and hold the power button  for more than three seconds. A menu will appear on-screen which allows you to power off the device. Make sure all user data and tasks have been stored before tapping on **Power off**.

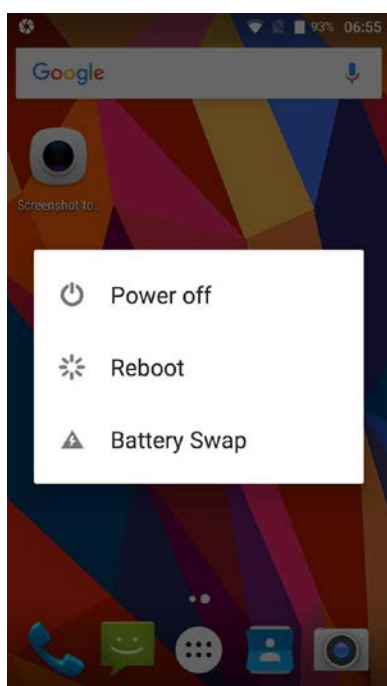



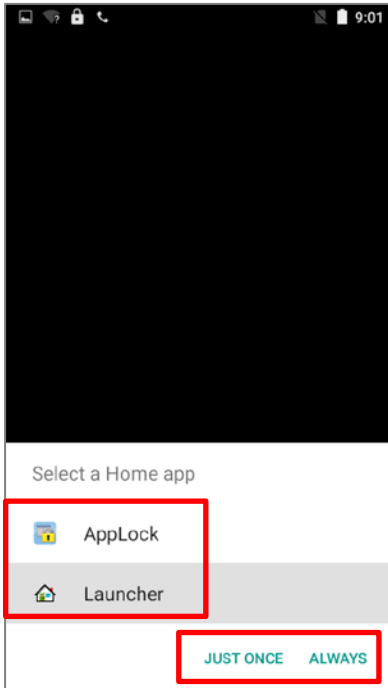

1.1.4. HOMESCREEN SELECTION

Upon the first time you launch the system, a **Select Home app** window will pop up to request your immediate choice of home screen. By selecting "**AppLock**", you will directly enter AppLock application (please refer to *AppLock User Guide* for detailed instructions on AppLock settings) to start configuring the interface provided to normal users of this device; by selecting "**Launcher**", you will enter the default Android™ 6.0 home screen.



1.1.5. USING HARDWARE BUTTONS

On the bottom of the mobile computer are three hardware buttons that deliver the following functions:

Button	Function	Description
	Back button	Returns to the previous screen or closes the active window or keyboard.
	Home button	Displays the Home screen.
	Recent apps button	Opens a list of recently used applications.
	Find button	Performs google search online

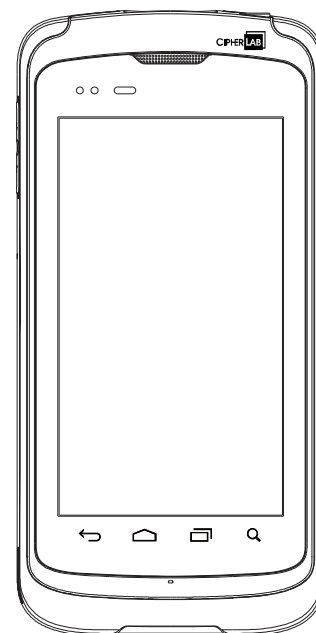

1.1.6. CONNECTING HEADSET

The headset jack is located on the top of the mobile computer. You can use the headset for audio playback or communication via the phone application, audio instant messaging, etc.

1.2. CHARGING & COMMUNICATION

1.2.1. CHARGE MOBILE COMPUTER

The main battery may not be charged to full for shipment. When you first receive the kit package, you will need to charge the main battery to full before using the mobile computer. You may use the Snap-on Charging Cable or Charging Cradle along with a power adapter to charge the mobile computer.

Your device can be charged as well when connected to a computer via USB cable; however, charging from a USB port on a computer is slower than charging using the Snap-on Charging Cable/Charging Cradle (all powered by the AC power adaptor).

CHARGING TIME

- ▶ Main battery: The main battery powers the mobile computer to work. It takes approximately 5 or 6 hours to charge an empty main battery to full. The charging LED above the screen (located on the right) will light up in red while charging and will turn green when charging is complete.
- ▶ When the main battery is removed, RTC retention will be maintained for at least 30 minutes.

Backup battery: The backup battery is mounted on the main board. Its role is to temporarily keep the mobile computer in suspension when the main battery is drained out so data in DRAM will be retained. The backup battery takes approximately 3.5 hours to charge to full by the main battery or power adapter.

CHARGING TEMPERATURE

- ▶ It is recommended to charge the battery at room temperature (18°C to 25°C) for optimal performance.
- ▶ Please note that battery charging stops when ambient temperature drops below 0°C or exceeds 40°C.

OPERATION ON BATTERY POWER

- ▶ When 802.11a/b/g/n/ac, GSM/GPRS/EDGE/WCDMA/HSPA/HSPA+/LTE CAT 6, Bluetooth v4.1 & v2.1+EDR and GPS are all enabled on battery power, the main battery level will drop down substantially. Prolonged use of the display and continued scanning of barcodes will also affect battery level.
- ▶ In order to prevent system from shutting down after the battery is drained out, we suggest that you keep a fresh battery for replacement at all times, or connect the mobile computer to an external power.

USE SNAP-ON CHARGING CABLE

The Snap-on Charging Cable provides a convenient way to charge your mobile computer.

- 1) Fasten the Snap-on Charging Cable to the lower end of the mobile computer.
- 2) Connect the other end of the cable to a USB port or the adaptor.
- 3) Fix the adapter plug onto the adaptor, and plug in into an electrical outlet.

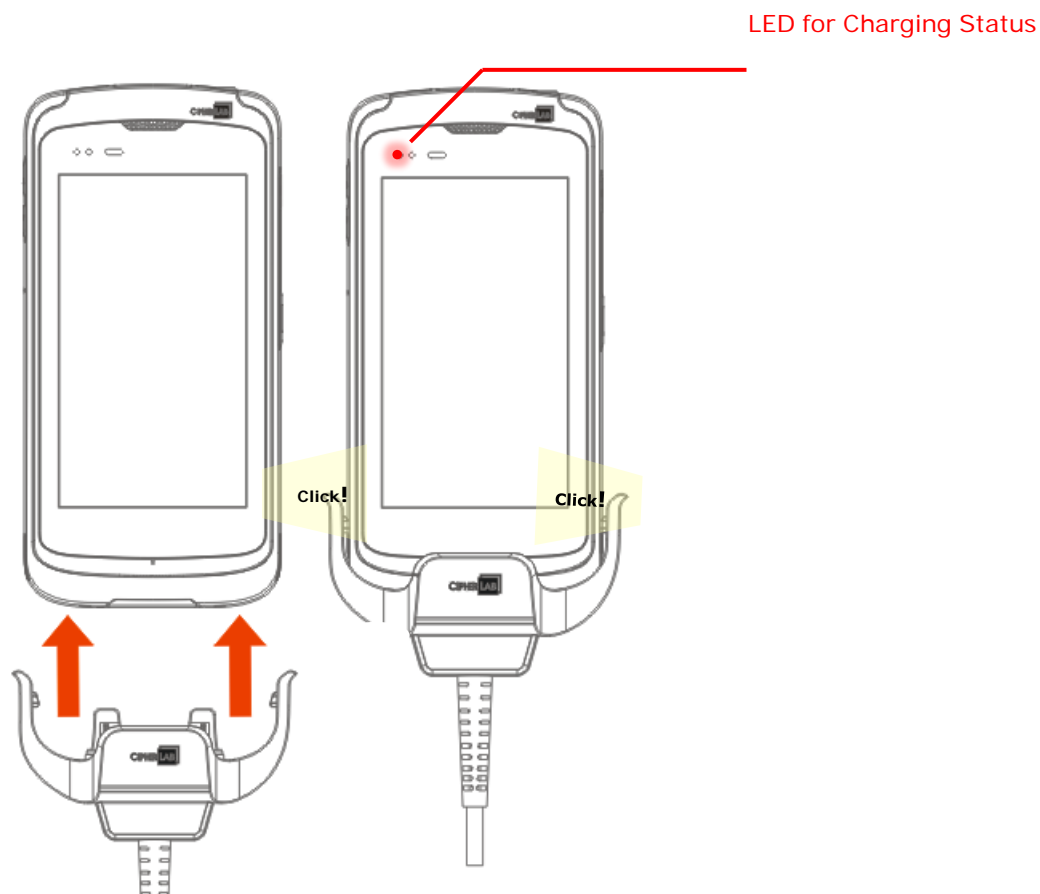

While the device battery is being charged, the LED indicators on mobile computer will indicate charging status.

LED Indicator	Status	Description
Charging Status	Red, solid	Charging in progress
	Red, blink	Charging error
	Green, solid	Charging completes
	No light	The cable is not correctly connected

USE CHARGING CRADLE

The Charging Cradle can charge your mobile computer and a spare battery at the same time.

- ▶ Presents charging compartment for mobile computer and spare battery
- ▶ Provides micro USB socket on the back for charging
- ▶ Supports USB Host Mode via a USB OTG cable
- ▶ Completes charging in approximately 5 hours
- ▶ Adapter input AC 100-240V, 50/60Hz; output DC 5V, 2A.

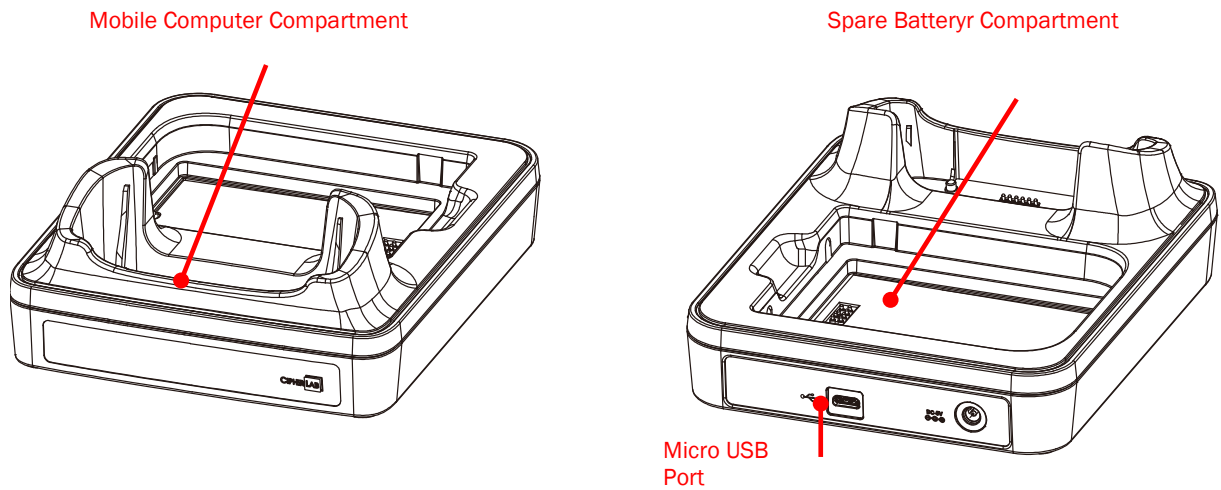

To charge your mobile computer via the Charging Cradle:

- 1) Smoothly insert the mobile computer into the Charging Cradle.

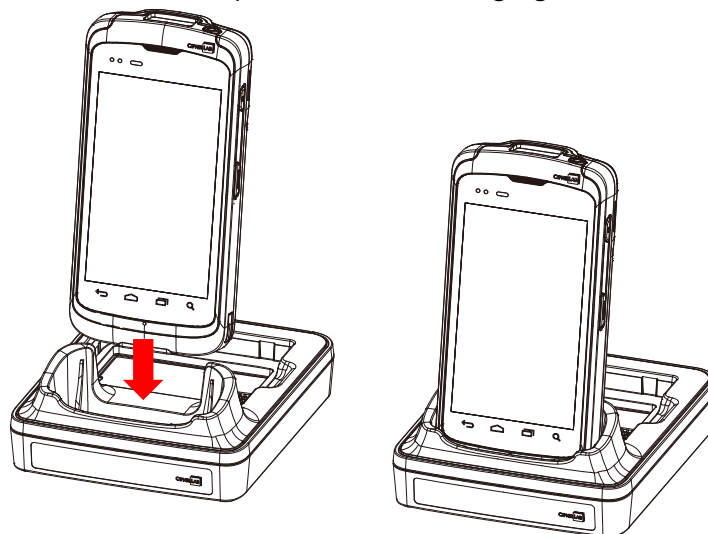

- 2) Connect the adapter to the Cradle, and plug the other end into an electrical outlet.

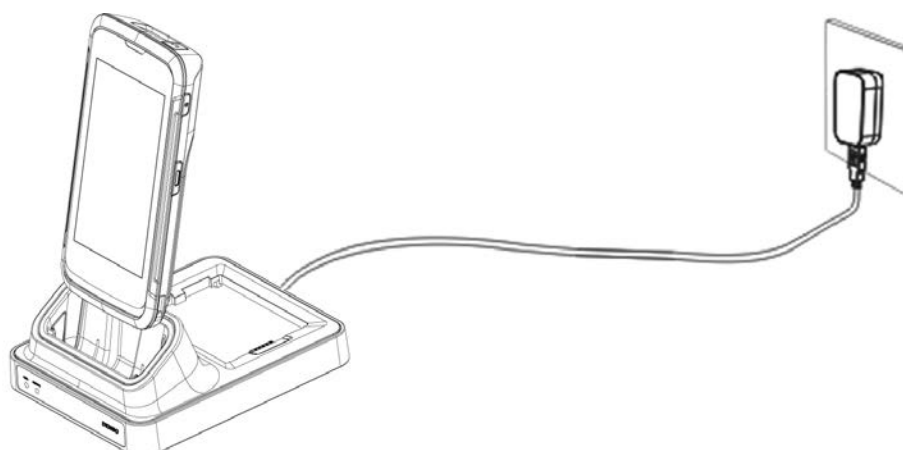

The status of the mobile computer charging is shown on the device itself; while the LED indicator on RS50 Charging Cradle shows the status of battery charging as below:

Cradle LED Indicator	Status	Description
Charging	Red, solid	Charging the battery
	Red, blink	Charging error
	Green, solid	Charging completes
	No light	Not charging

Note:

- (1) **Not Charging** could be the result of battery damage, battery's failure to touch the connector, or AC plug coming off.
- (2) *Charging error* could be due to high battery temperature.

1.2.2. WIRED DATA TRANSMISSION

Use the Snap-on cable to connect the mobile computer to your PC for data transmission.

- 1) Connect your device to the computer with the supplied Snap-on cable.

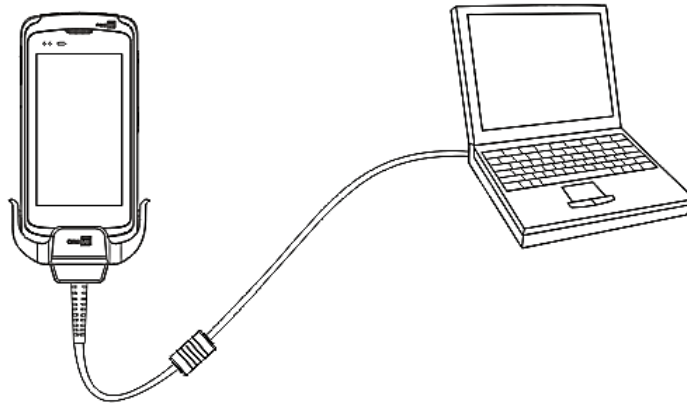

- 2) Swipe down from the status bar to reveal Notifications Drawer.
- 3) Tap "USB for Charging" to enter USB options. "Transfer files" (MTP) is set by default to transfer all types of files between your device and PC. To transfer videos and photos, you can select "Photo transfer (PTP)", in which your device will share only videos and photos in DCIM and Pictures folders. Choosing "Charging only", the device will be in charging mode, in which you are unable to access the files on this device from the PC client.

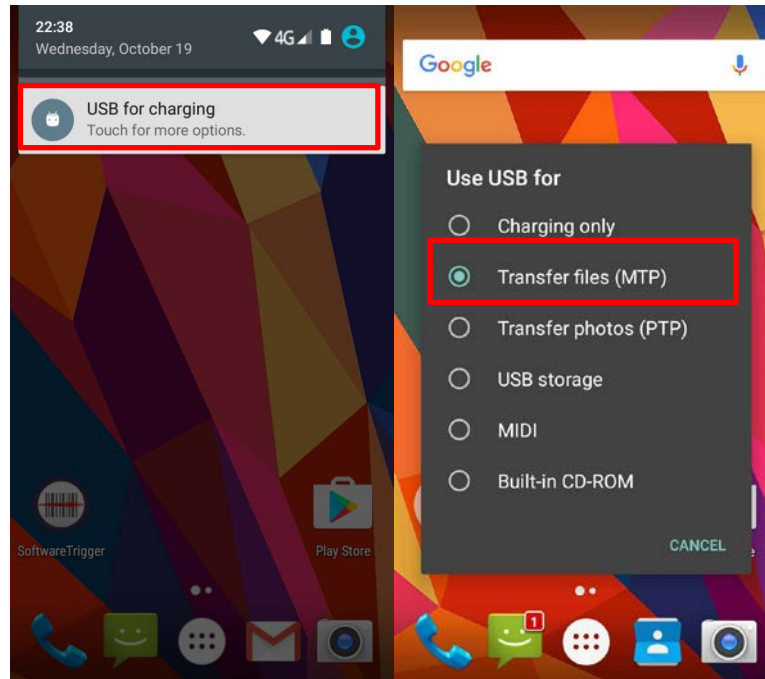

1.2.3 USING WIRELESS NETWORKS

The mobile computer supports widely applied wireless technologies including Bluetooth v4.1 & v2.1+EDR, 802.11 a/b/g/n/ac, and is able to send/receive data in real time in an efficient way. Select GSM/GPRS/EDGE/WCDMA/HSPA/HSPA+/LTE CAT 6 modules embedded for a total wireless solution for data and voice communication.

Chapter 2

USING THE RS50 MOBILE COMPUTER

This chapter walks you through the fundamental usage and features of this device.

IN THIS CHAPTER

2.1 Battery	33
2.2 Memory	42
2.3 Touch Screen	51
2.4 Notifications	56
2.5 Date and Time	60
2.6 Language & Keyboard Input	62
2.7 Sound and Volume	70
2.8 Programmable Keys	71
2.9 Data Capture.....	77

2.1. BATTERY

▶ Main Battery

The mobile computer is powered by a rechargeable 3.8V / 4000 mAh or 3.8V / 5000 mAh Li-ion battery pack. It takes approximately 4 hours to charge it to full from the power adaptor. However, the charging time may vary by your working condition.

▶ Spare Battery

A spare battery pack is provided as an accessory. We recommend keeping a fully charged spare battery at hand in order to replace the main battery when it is nearly drained out.

▶ Backup Battery

Settled on the main board is a backup battery that keeps the mobile computer in suspension when the main battery is depleted. The backup battery is a 60 mAh rechargeable Li-ion battery, and can retain data in the DRAM for 30 minutes when it is fully charged (as long as wireless modules on the mobile computer are inactive). The backup battery can be charged by the main battery or the power adaptor, and takes approximately 3.5 hours to charge to full.

Warning:

- (1) The battery must be secured in position. If not, the mobile computer cannot turn on by pressing the power key.
 - (2) For a new battery, make sure it is fully charged before using.
 - (3) To avoid data loss, when replacing the main battery, make sure you replace it with a well-charged spare battery pack. Always prepare a spare battery at hand, especially when you are on the road.
 - (4) When the mobile computer has been on backup battery for 30 minutes, the system will shut down. Be sure to replace the main battery as soon as possible in order to avoid data loss.
-

2.1.1. BATTERY STATUS INDICATORS

The main battery pack is the only power source for the mobile computer to work. Therefore, when the main battery level goes low, you need to replace the battery pack with a charged one or charge it as soon as possible. Most of all, you should backup important data on a regular basis.

By checking the battery status icon on **Status Bar**, you can tell the battery level remaining in the main battery.

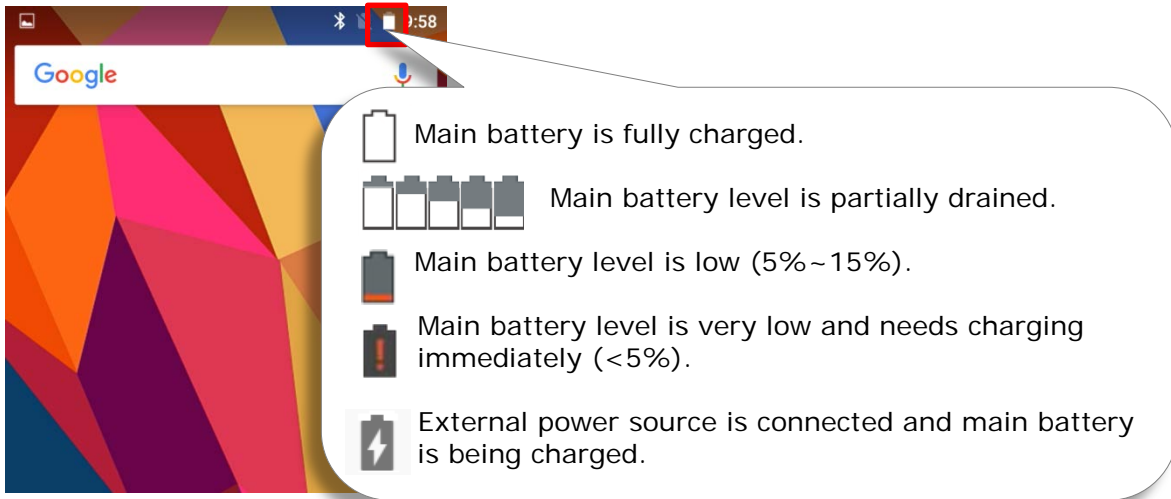

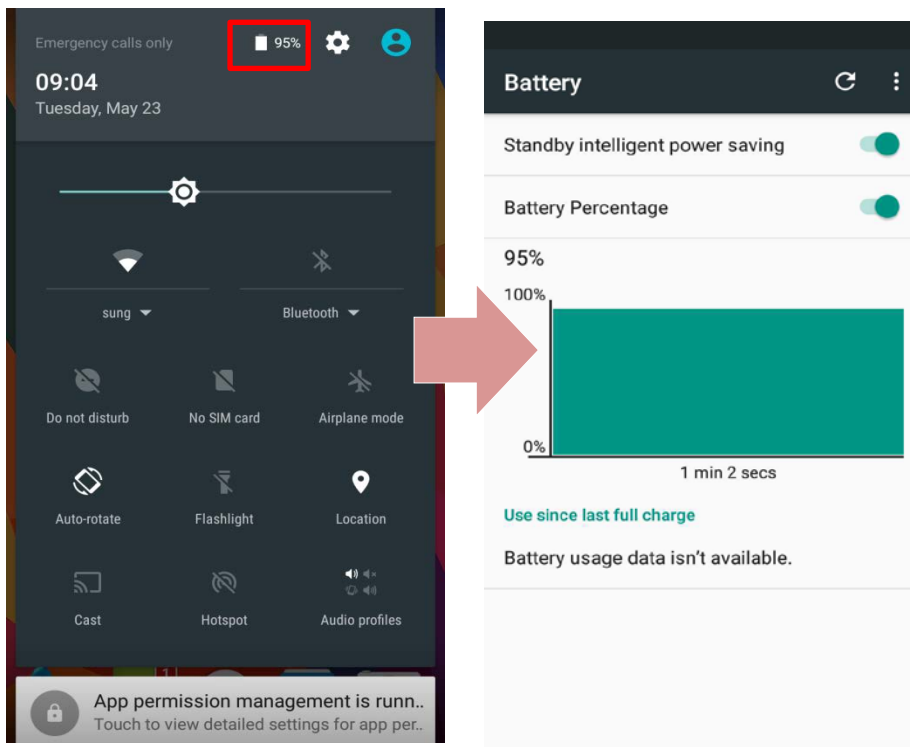

To check the exact remaining percentage of power and battery life:

- 1) Use two fingers to swipe down from the top of the screen to open **Quick Settings**.
- 1) The percentage of remaining battery power is shown beside the battery icon; you can tap on it to enter **Battery Settings** for more details and configurations.



Note:

When the mobile computer is fully charged and battery level reaches 100%, the battery icon will change from  to  to indicate charging is completed.

Warning:

- (1) Once the battery level drops below 15%, the low battery notification will be displayed on the screen.
 - (2) Data loss with RAM may occur when battery level is low. Always save data before the battery runs out of power or keep a fresh battery for replacement.
 - (3) Constant usage of the mobile computer at low battery level can affect battery life. For maximum performance, recharge the battery periodically to avoid battery drain out and maintain good battery health.
-
-

2.1.2. MONITOR BATTERY LEVEL

MAIN BATTERY LEVEL

The main battery is the only source that feeds the mobile computer to work. It also supplies the backup battery on the main board in order to retain the data stored in DRAM. When main battery level gets low, recharge it or replace it as soon as possible. Most critically, back up the important data from time to time to protect your work.

To check main battery level:

Tap **All Apps**  | **Settings**  | **Battery**  .

Battery level percentage is shown to provide a clear grasp of the remaining battery power. The screen also shows the rate of battery discharge since the last battery charging session, how long the device has been running on battery power, and which applications are consuming the most battery power.

- ▶ To enable Android's smart power saving feature, activate the **Standby intelligent power saving function**, which intelligently manages the background tasks as this device is powered on.
- ▶ To look at the timeline of each application that drained or has been draining the battery power, tap on the chart; with this, you can diagnose any serious power drains.

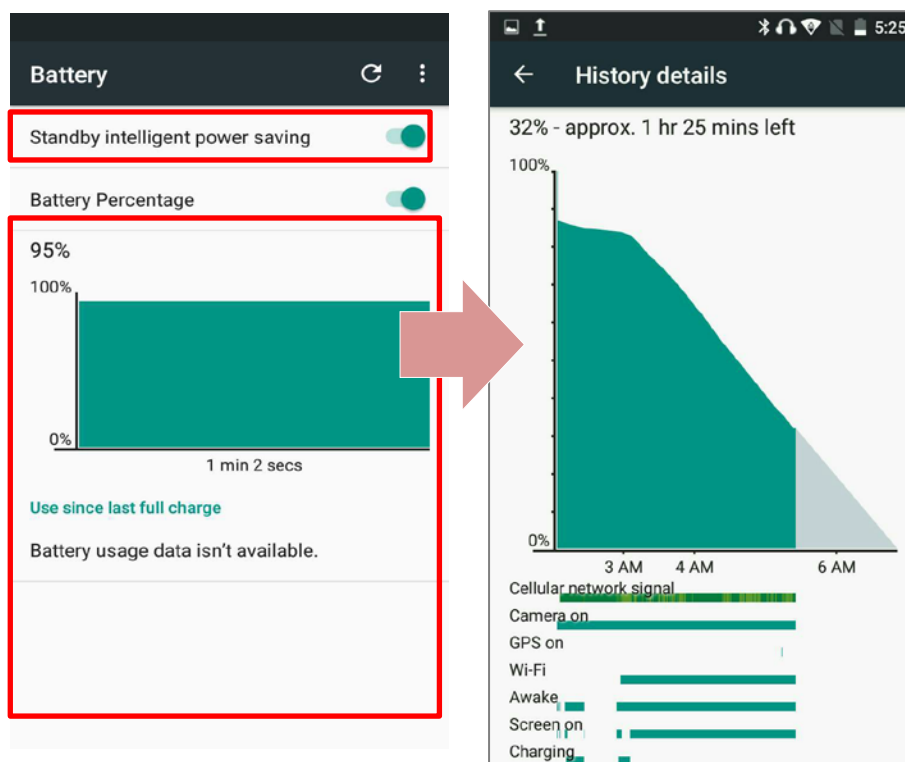

BATTERY SAVER MODE

You can have the **Battery saver** mode automatically turned on when the main battery gets low. This mode will limit the use of location services, vibration and most background processing data. On **Battery** screen, tap on **More**  and then select "**Battery saver**".

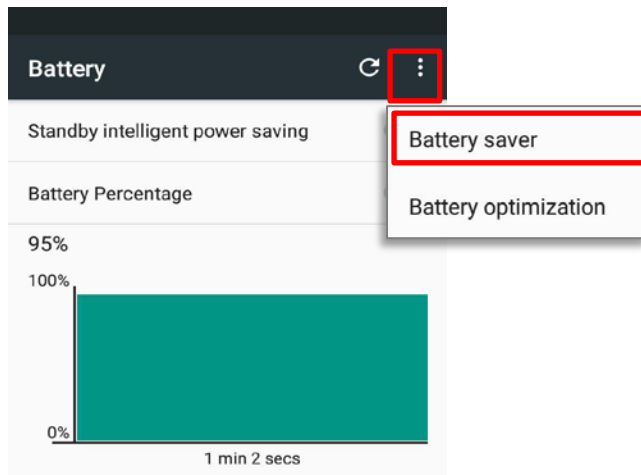

Switch on the function and choose when to have this mode automatically activated.

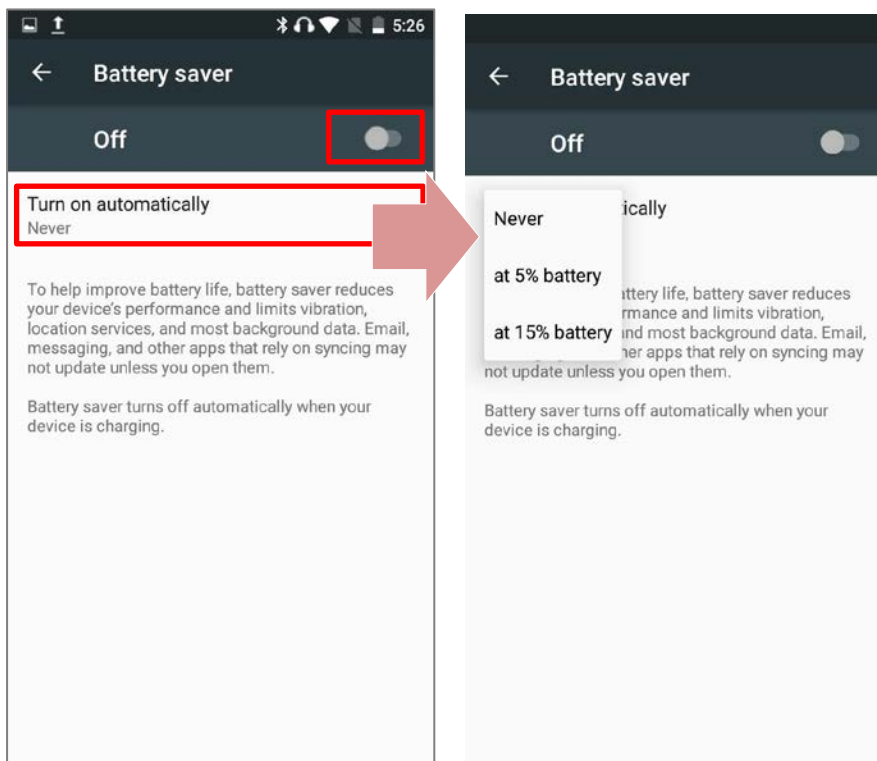

Note:

This mode will automatically become inactive when your device is being charged.

BATTERY OPTIMIZATION

With **Battery optimization** enabled for the applications, you can make sure they stay inactive when your device is idle or when they have not been used for days.

- 1) On **Battery** screen, tap **More**  and then select "**Battery optimization**".

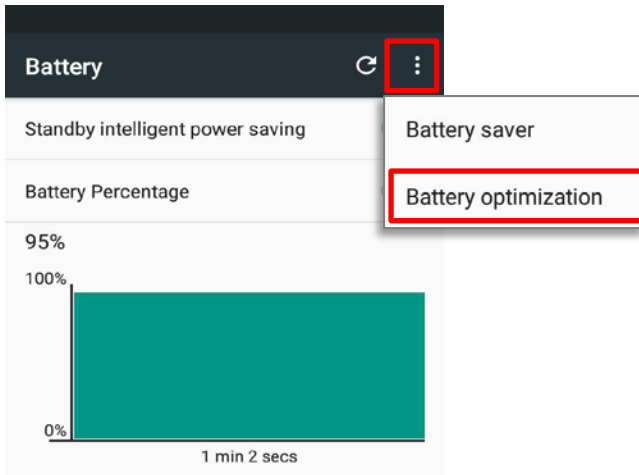

- 2) On the dropdown list, select "**All apps**", all the applications will be optimized by this function by default. You can individually turn off the optimization mode of a certain app if you would like it always activated by tapping on the app name and select "**Don't optimize**" and then "**DONE**".

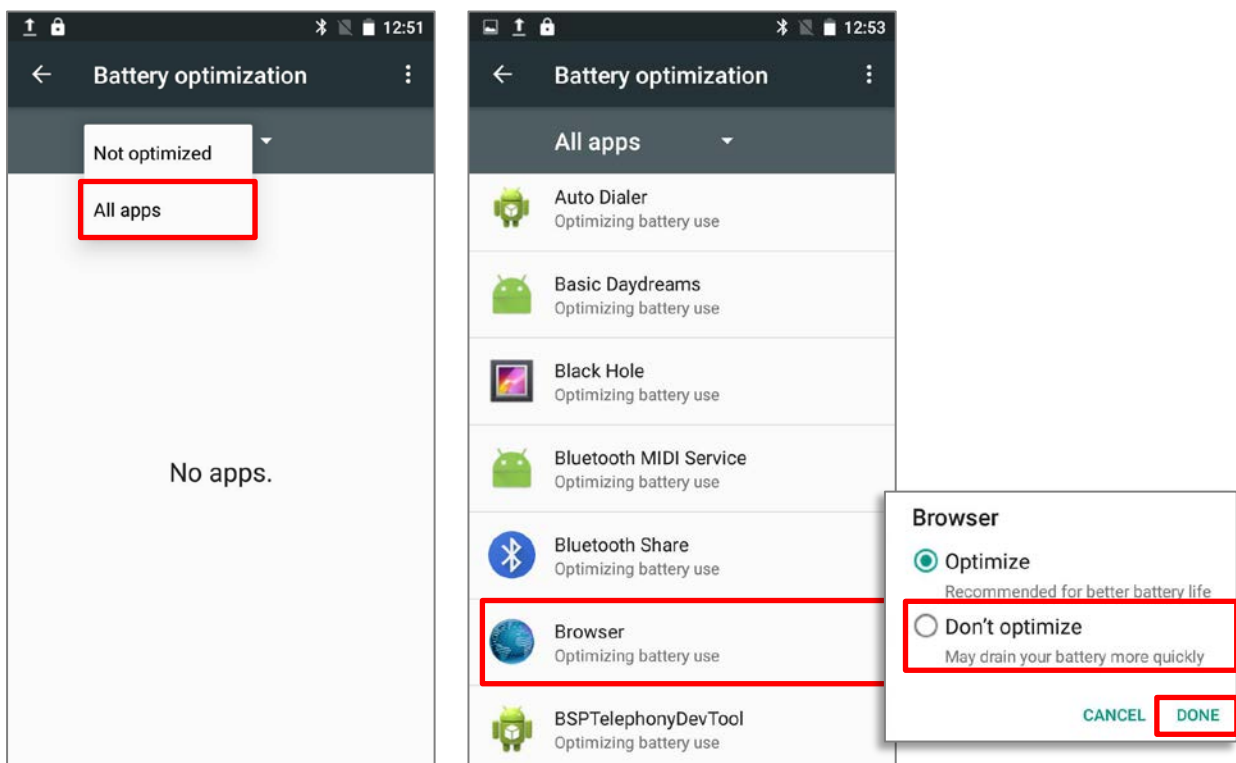

LOW BATTERY ALERT

The mobile computer prompts a warning notification reminding you to charge the main battery when the main battery level drops to **15%** and **5%**. In the meantime, the device's status LED indicator will blink red.

Opening [Notifications Drawer](#), you will also see this warning appearing on the notifications list; you may turn on [Battery Saver Mode](#), connect the mobile computer to an external power source, or replace the main battery pack as soon as possible. To replace the main battery pack, see [Replace Main Battery](#).

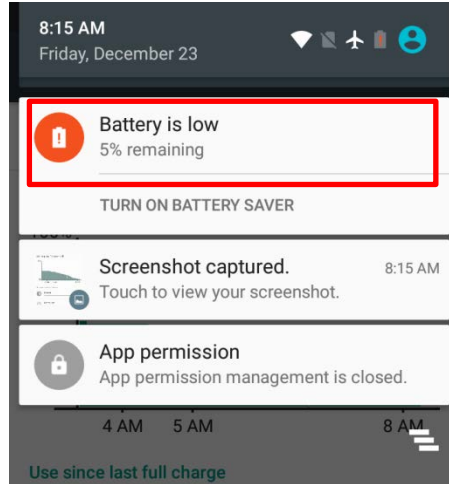
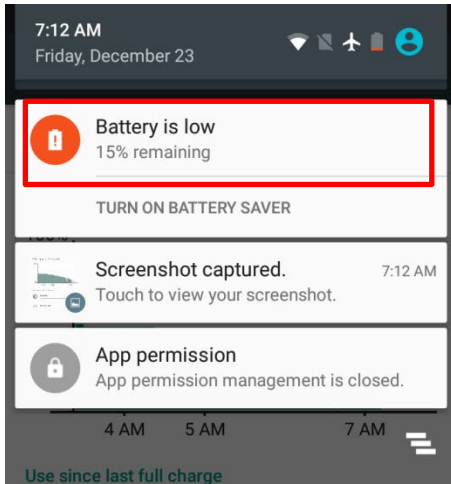

2.1.3. REPLACE MAIN BATTERY

When main battery level is low, follow the steps below to replace the main battery.

RS50 backup battery supplies system power during battery swap.

- 1) Make sure the new battery is fully-charged.
- 2) Press and hold the power button on the side of the mobile computer.
- 3) Tap "**Battery Swap**" in the pop-up menu.

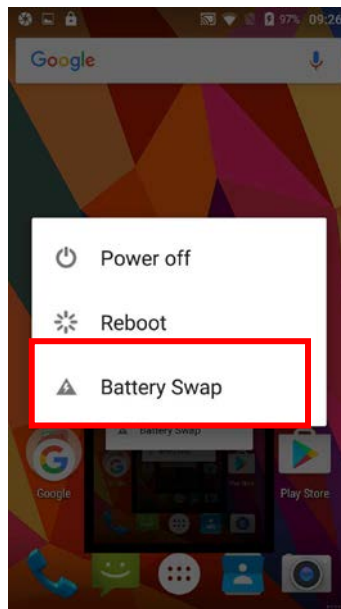

- 4) Follow the steps described in [Installing Battery](#) to remove the battery.
- 5) Observe the power LED light; as it goes off, the device is in complete suspend mode and Main battery is ready to be replaced. Remove the battery and replace it with the new one.
- 6) Install the battery and press the power button to wake up the mobile computer.

Note:





- (1) When the main battery is removed, the system will stay in suspend mode for 30 minutes. To prevent the system from being shut down without advance warning, please DO replace the main battery within the 30 minutes.
 - (2) The system time will be set to default if the main battery is not replaced within ten seconds.
-

2.1.4. POWER MANAGEMENT

For any portable device, power management is a critical issue especially when you are on the road. Below are some tips to help you save battery power.

Warning:

Using backlight, wireless connectivity, and peripheral devices on battery power will substantially reduce battery power.

- ▶ Bring an additional main battery pack with you on the road.
- ▶ End wireless connections (such as Bluetooth transmission, WLAN, WWAN, NFC and GPS) which are not in use.
- ▶ Shorten the time interval of turning off screen. See [Screen Timeout Settings](#).
- ▶ Reduce the screen brightness level, see [Screen Brightness](#).
- ▶ If you have had your Google account signed in on this device, you could turn off certain automatic data syncing of applications (such as Email, Calendar, and Contacts). Go to **All Apps**  | **Settings**  | **Accounts**  | **Google**  and disable the data syncing services of your desired items.
- ▶ Enable **Battery saver** mode and **Battery optimization** mode. See [Battery Saver Mode](#) and [Battery Optimization](#).

ENTER AIRPLANE MODE

You can enable **Airplane** mode to have all the wireless radios (including call functions, data connections such as Bluetooth, Wi-Fi and 3G/4G) on your mobile computer turned off, which will considerably reduce the power consumption of your battery.

- 1) To enter **Airplane** mode, use two fingers to swipe down from the top of the screen to open **Quick Settings**.
- 2) Tap on the **Airplane mode** icon to enable/disable it.

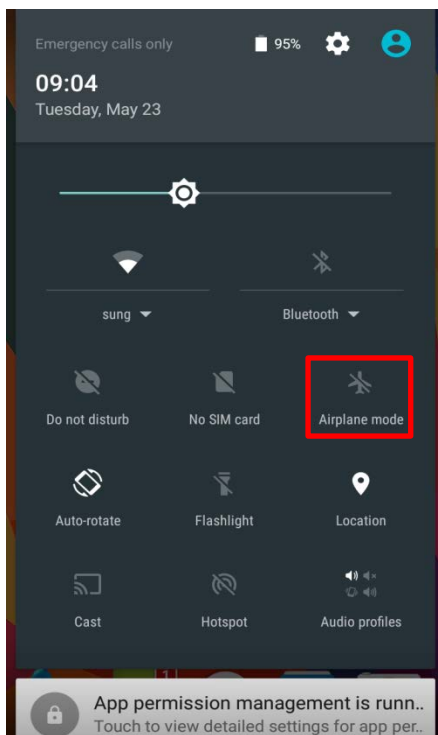

2.2. MEMORY

- ▶ Flash Memory (ROM)
16GB flash memory for storing the OS (Android™ 6.0 Marshmallow and custom application programs..
- ▶ Random Access Memory (RAM)
2GB RAM for storing and running programs, as well as storing program data.
- ▶ Expansion Slot
The mobile computer is equipped with one SD card slot which can accommodate a micro SD card, a microSDHC or a microSDXC card. When choosing an SD card for best compatibility and performance with RS50, please make sure of the capacity you need. For the use of SDXC card, please use a new card and make sure it has not been used in other host devices (computers, cameras, or readers).

Card	Capacity
SDXC	64GB-2TB
SDHC	4GB-32GB
SD	128MB-2GB

CAUTION OF DATA LOSS

When the main battery is removed or drained, the backup battery on the main board takes over to supply the mobile computer and keep it in suspension. A fully charged backup battery will retain the data in the RAM for **30 minutes**. When the backup battery is drained out as well, the mobile computer will shut down, and only the contents of RTC will be retained. All other unsaved data will be lost.

If you want to put away the mobile computer for a couple of days, you should be aware that data loss occurs when the main battery and backup battery discharges completely. Therefore, it is necessary to backup data and files before putting away the mobile computer.

2.2.1. CHECK MEMORY USAGE

The memory manager can offer a glance of how the device is using its RAM.

Tap **All Apps**  | **Settings**  | **Memory**  to enter memory manager screen.

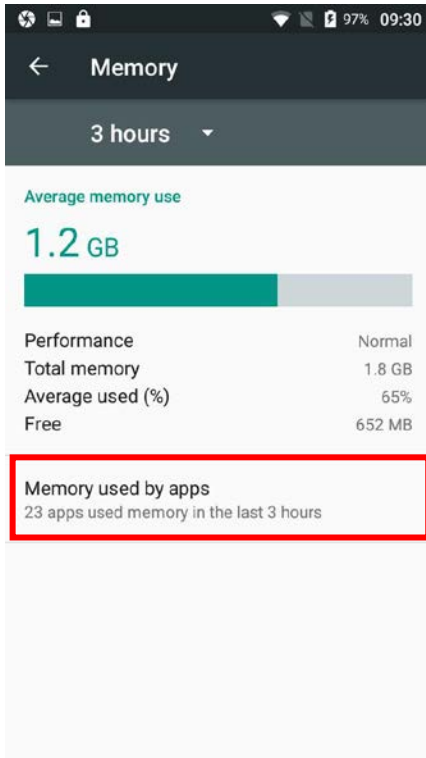

On the main screen, it tells you not only the used and free memory space of the RAM, but how your pattern of usage has impacted the device's overall performance. To figure out how the system and apps have been taking up the memory over a longer period, tap the dropdown list to choose a different time span.

To look at how individual apps are consuming the memory space, tap "**Memory used by apps**" to get a breakdown of memory usage by apps.

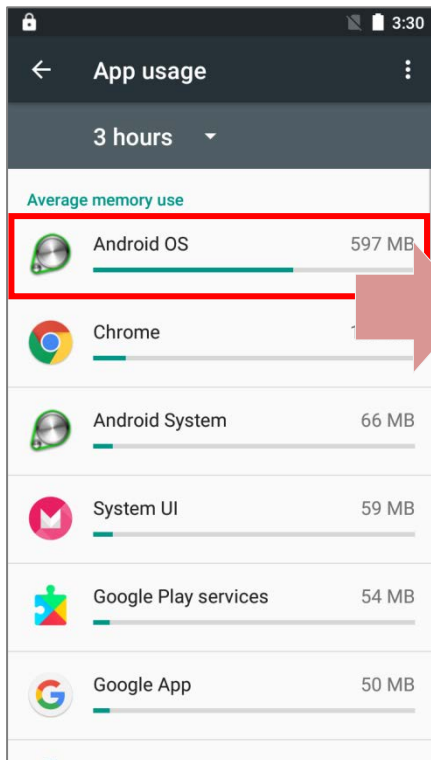

Tap an application name to check its memory usage. This allows you to make sense of how much memory a newly-installed application can potentially consume your RAM.

2.2.2. MANAGE STORAGE SPACE

The SD card can serve as an extension of your Android device's internal storage (which comes as 16 GB of flash memory to store the OS, applications and files) other than a portable storage place.

Tap **All Apps**  | **Settings**  | **Storage & USB**  to check usage of the internal and external storage spaces.

CHOOSE DEFAULT STORAGE

By default, all the videos, photos and downloaded files are directly saved to the device's internal storage. If you have previously inserted and mounted an SD card as portable storage, this external storage will appear selectable below the option **Internal Storage**, and you can choose it as the **Default write disk**.

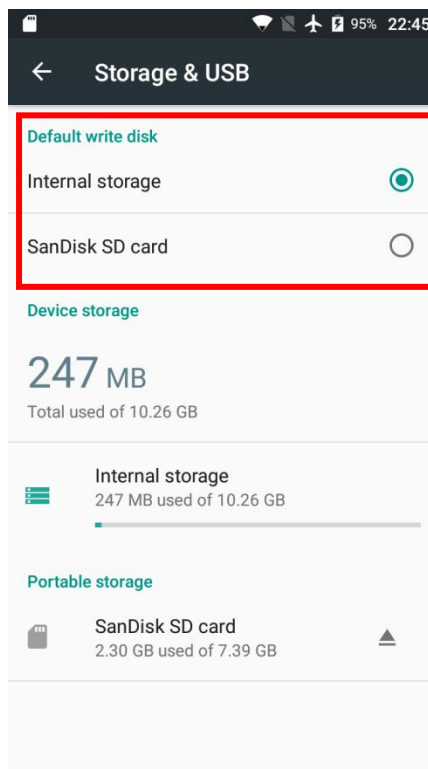

SET UP SD CARD AS PORTABLE STORAGE

Using SD card as a portable device allows you to treat it as a USB disk, by swapping it between your Android device and the computer to easily transfer files. This is quite handy when there is a need to offload files that are taking up too much storage space.

When this device is connected with PC, the disk content is readable from PC client:

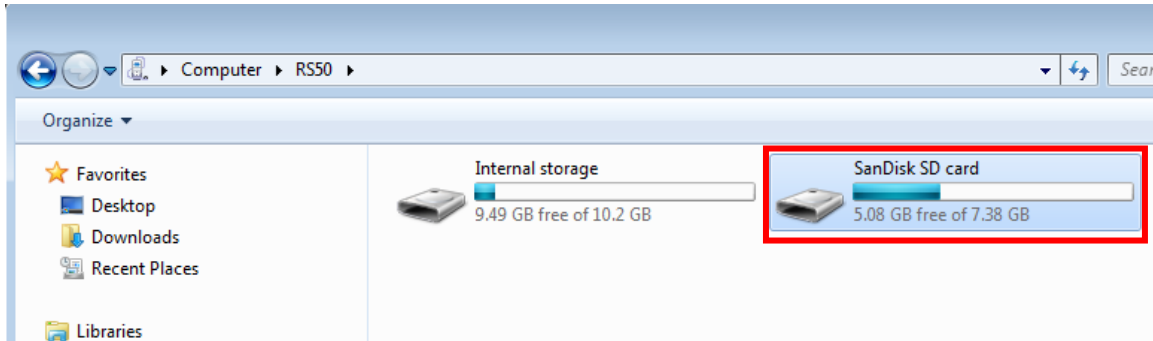

On **Storage & USB** screen, this disk can be managed separately.

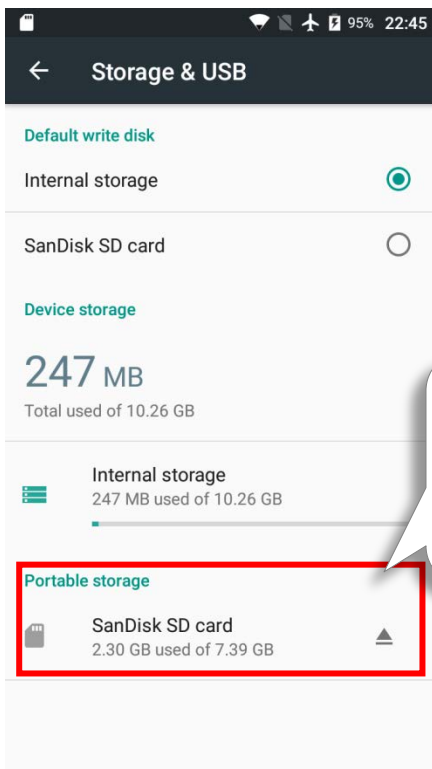

The SD card is considered a separate storage, the capacity of which is not included in total device storage. You can tap  to eject a mounted SD card.

To start:

- 1) Connect your mobile computer to PC with the supplied USB cable, swipe down from the status bar to reveal [Notifications Drawer](#), tap "**USB for file transfer**" to choose other options as needed.
- 2) With an SD card inserted, a notification will pop up indicating that an SD card is detected. Tap "**SET UP**".
- 3) Tap "**Use as portable storage**" and then "**NEXT**".

- 4) Tap **“ERASE & FORMAT”** to format this card. The file format allows the card to be readable on other devices such as PC or a digital camera.

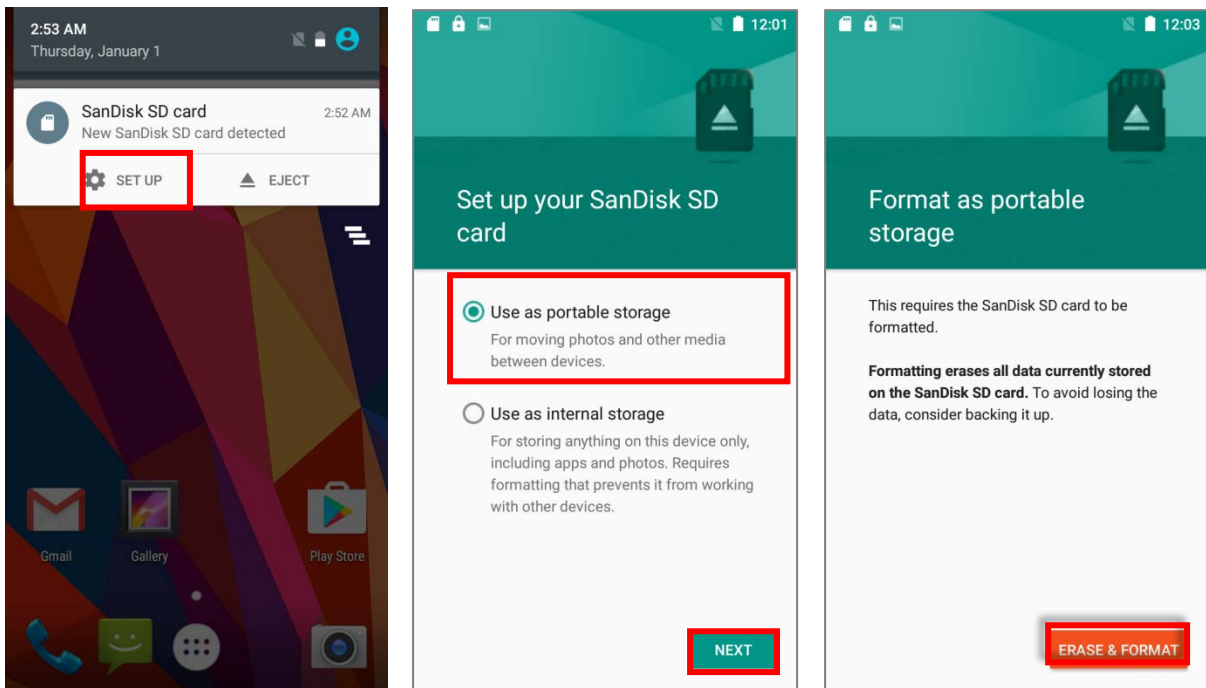

- 5) At the window asking you whether to change the write disk from internal storage (default) to the SD card, tap **“OK”** to do so or **“Cancel”** to stay with the default setting.
- 6) When the setting is completed, tap **“DONE”**.

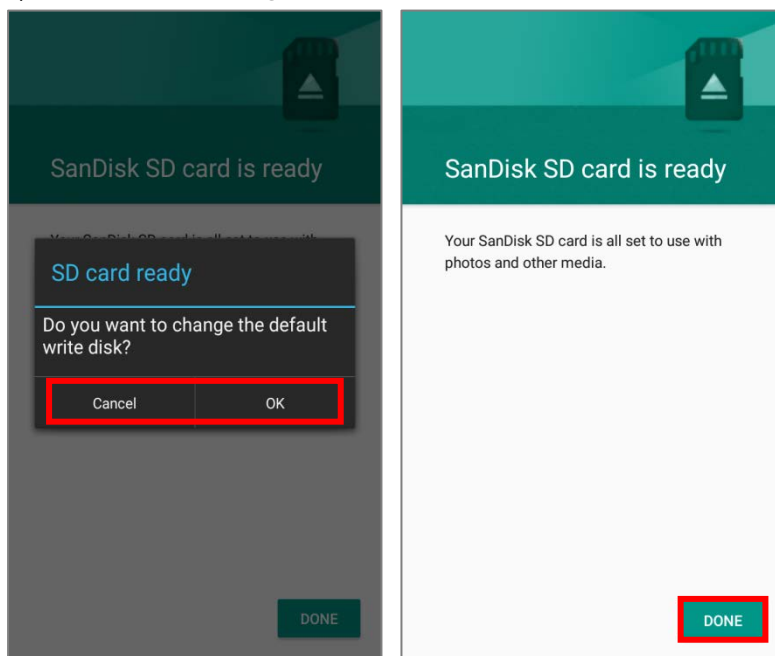

Note:

Please make sure the USB cable is properly connected while transferring files over USB connection.

CONVERT THE SD CARD TO INTERNAL STORAGE

- 1) You can always convert the SD Card from portable storage to internal storage. On **Storage & USB**, tap the SD card radio button. Before you start, make a backup of the files on this disk if you would like to keep them.
- 2) On the SD card content screen, tap **More**  and then tap **Settings**.
- 3) By selecting **Format as internal**, the device will eventually format this SD card into a specific file format only readable by this device.

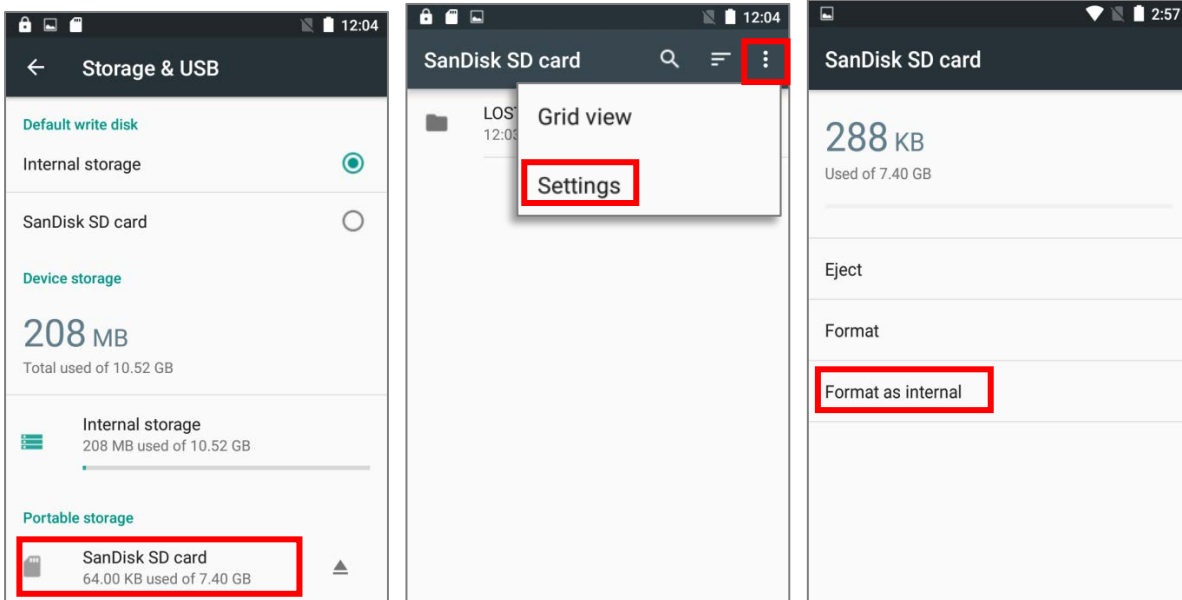

- 4) On the **Format as internal storage** screen, tap **ERASE & FORMAT** to format the card.
- 5) You will then be asked whether to move media files to this new SD card right away or later; make your choice and then tap **Next**.
- 6) When the formatting is completed, tap **DONE**.

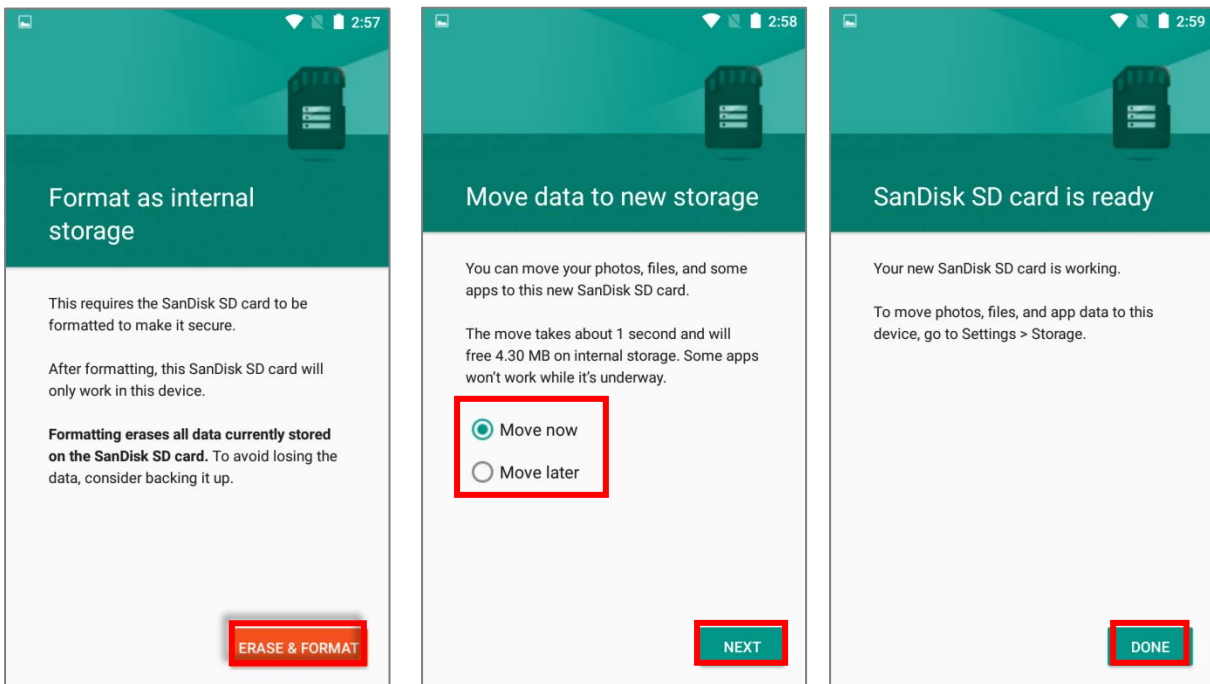

SET UP SD CARD AS INTERNAL STORAGE

Using SD card as internal storage allows you to extend your existing device storage and to store huge applications. This SD card will be reformatted and encrypted with a file format that is not readable by another device. Therefore, it is essential that you back up important files on this SD card in advance. Please note that if you eject this SD card, the applications and media files stored on it will not be available until you reinsert the card.

When this device is connected with PC, the disk content is not readable from PC client:

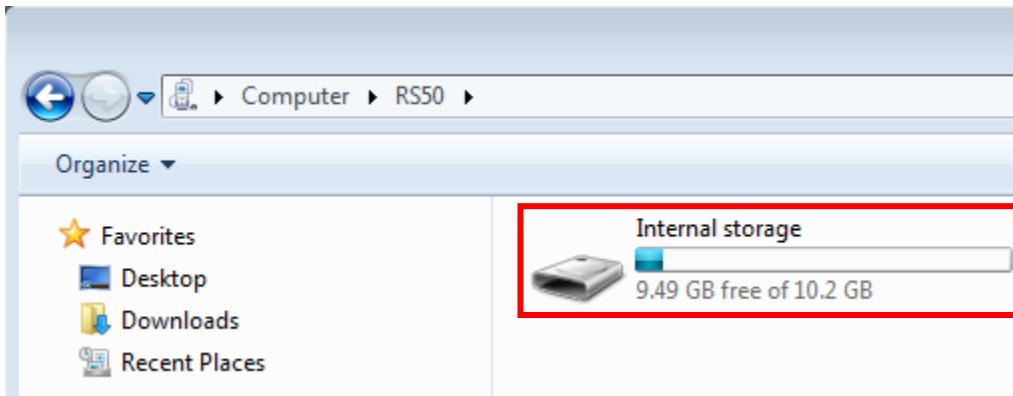

On the **Storage & USB** screen, the capacity of this SD card is merged into the total device storage. Please note that. In this setting, you will have no control of which files to be stored on SD card.

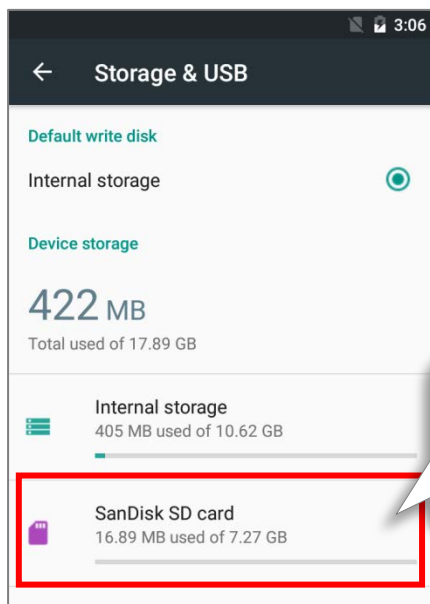

To eject this SD card:
1) Select this SD card.
2) On SD card content screen, tap **More**  and then tap **"Eject"**.

Warning:

Do not physically remove the SD card from the device without ejecting this card in advance.

To start:

- 1) Insert the SD card. A notification will pop up indicating that an SD card is detected tap **"SET UP"**.
- 2) Tap **"Use as internal storage"** and then **"NEXT"**.
- 3) Tap **"ERASE & FORMAT"** to format this card.

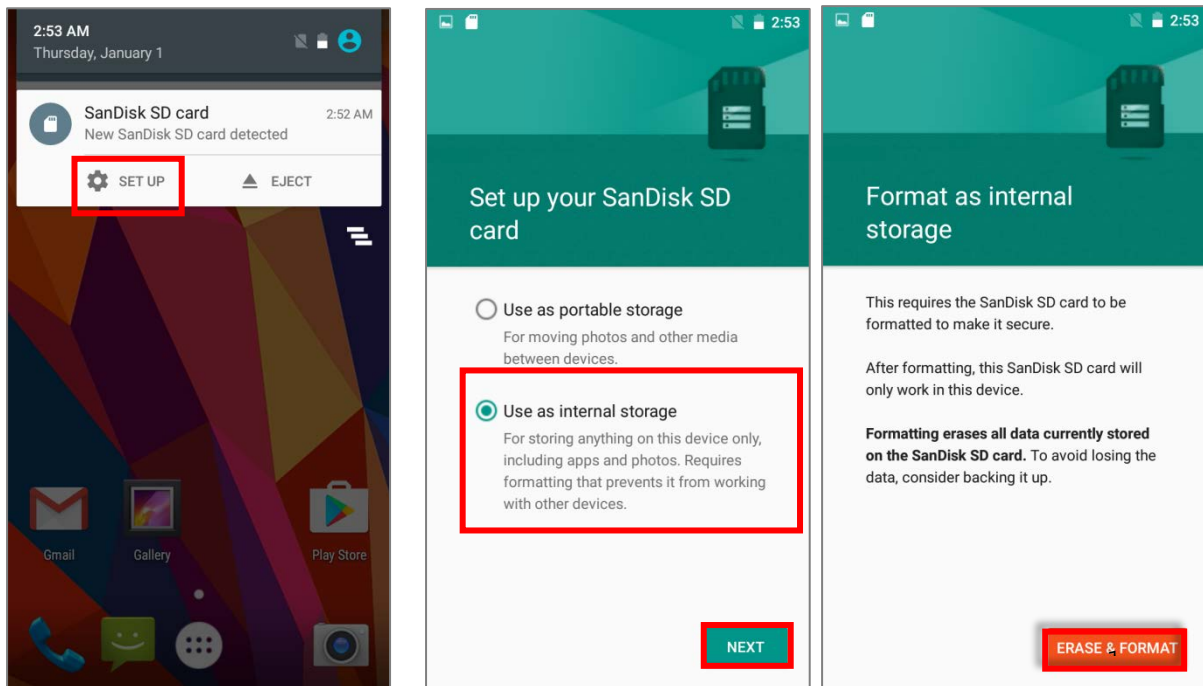

- 4) You will then be asked whether to move media files to this new SD card; make your choice and then tap **"Next"**.
- 5) When the setting is completed, tap **"DONE"**.

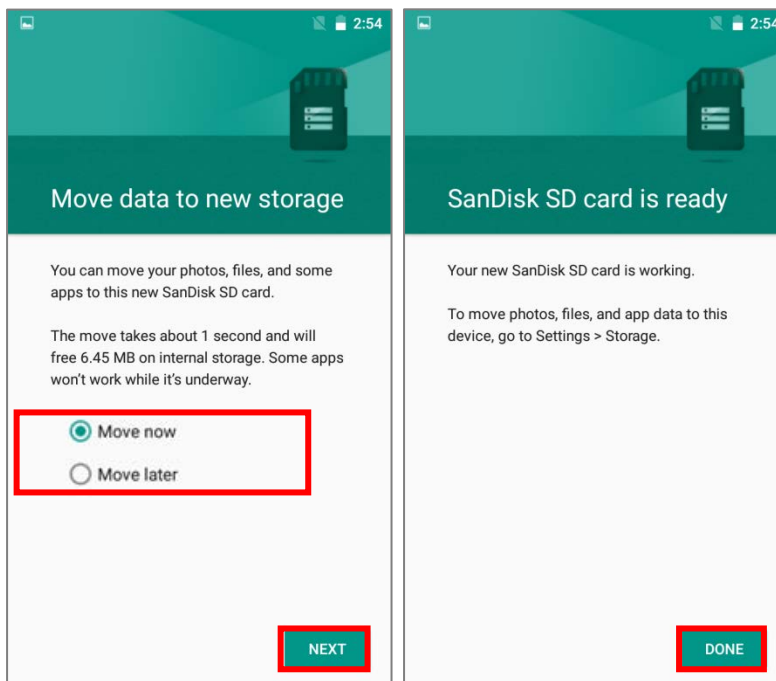

Note:

It is recommended that you select **"Move now"** at **Step 4** to have the device immediately start making use of SD card space. If you select **"Move later"**, the device will continue to consider device's original storage the primary location to save files.

CONVERT THE SD CARD TO PORTABLE STORAGE

- 1) You can always convert the SD Card from internal storage to portable storage. On **Storage & USB**, tap the SD card. Before you start, make a backup of the files on this disk if you would like to keep them.
- 2) On SD card content screen, tap **More**  and then tap **“Format as portable”**.
- 3) Tap **“Format”** to have this SD card re-formatted into a file type inaccessible by other devices.

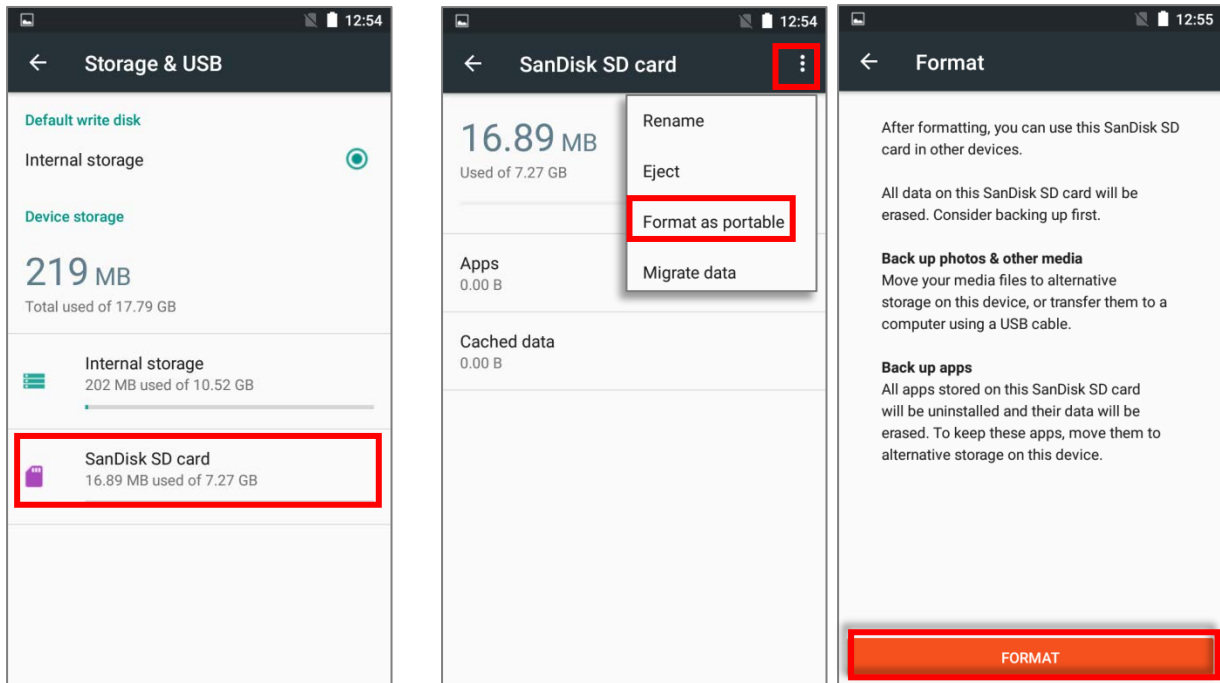

- 4) On the **Move data now** screen, tap **“MOVE”** to migrate data from the device's storage to SD card and have the SD card become the primary storage location.
- 5) When the formatting is completed, tap **“DONE”**.

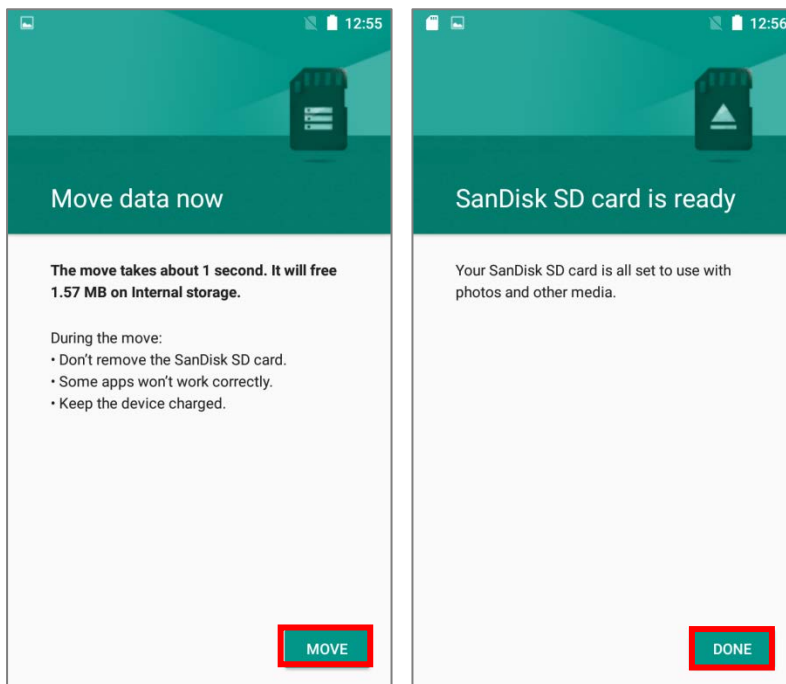

2.3. TOUCH SCREEN

The mobile computer comes with a 4.7" transmissive LCD with 1280 by 720 pixels resolution (HD). The LED backlight of the screen, which helps ease reading under dim environments, can be controlled manually and automatically.

Warning:

DO NOT use any pointed or sharp objects to move against the surface of the screen.

2.3.1. SCREEN BRIGHTNESS

Tap **All Apps**  | **Settings**  | **Display**  | **Brightness level**.

Adjust screen brightness by dragging the slider to the right (to increase brightness) or left (to reduce brightness). Switch on the **Adaptive brightness** to enable automatic backlight adjustment with the mobile computer's built-in sensor. You can also use the shortcut button on **Quick Settings** menu to adjust the brightness level.

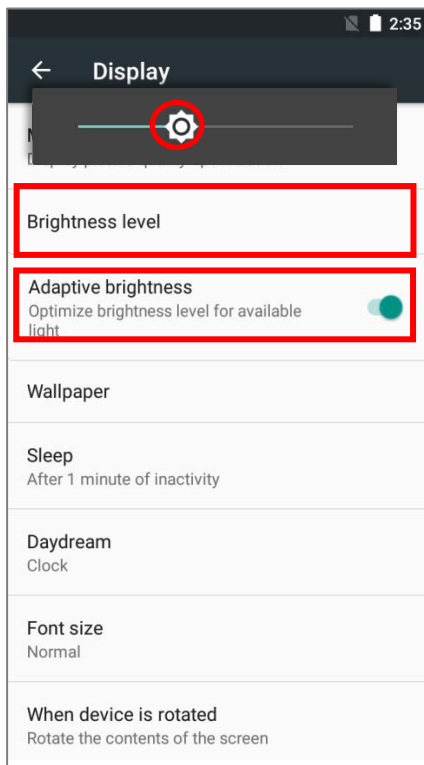



Note:

To save battery power, dim the screen brightness while working in a well-lit area, or set a shorter sleeping plan for the screen backlight to go off.

2.3.2. SCREEN ROTATION

By default, the device automatically rotates the screen when you turn the device sideways. To switch this function on or off:

- 1) Tap **All Apps**  | **Settings**  | **Display** .
- 2) Tap **When device is rotated** and then select **Stay in portrait view** to turn the rotation function off or tap **Rotate the contents of the screen** to enable it.

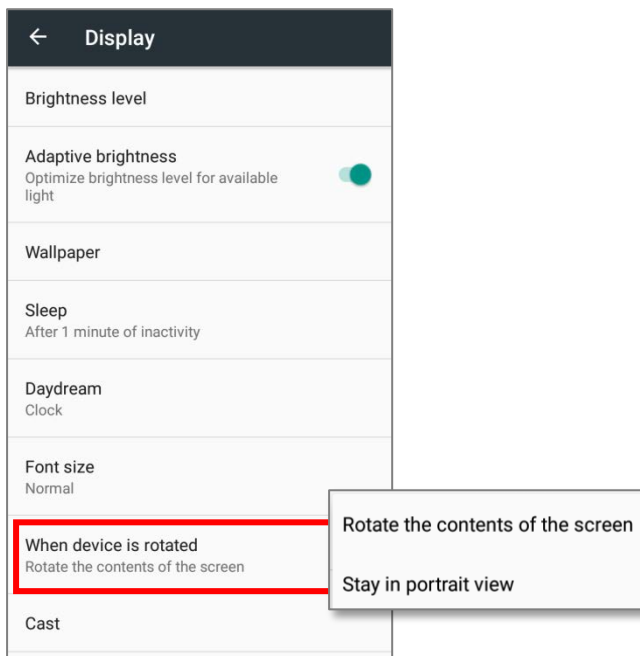



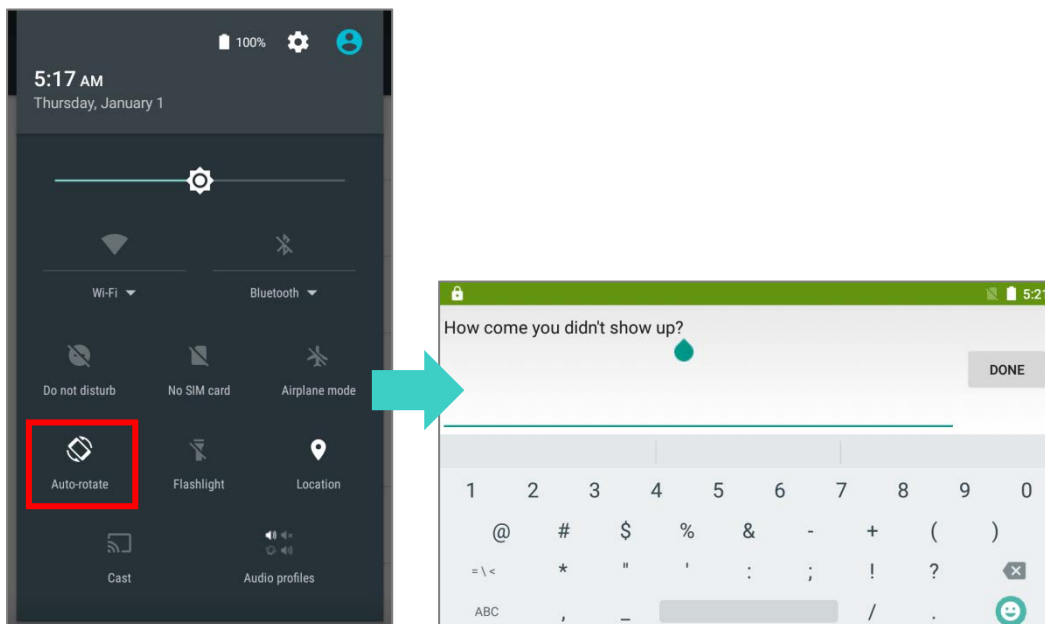

OR

- 2) Use two fingers to swipe down from the top of the screen to open **Quick Settings** and tap the **Auto rotate** status icon. This quick setting method allows you to temporarily enter landscape mode to enhance your typing experience by using a wide keyboard.



You can entirely disable the switch on the interface to minimize the possibility of accidentally turning on the auto-rotation function.

Tap **All Apps**  | **Settings**  | **Accessibility**  and switch off **Auto-rotate screen**. By doing so, the auto-rotation option will be hidden on **Quick Settings** menu as well as in **Settings**  | **Display** .

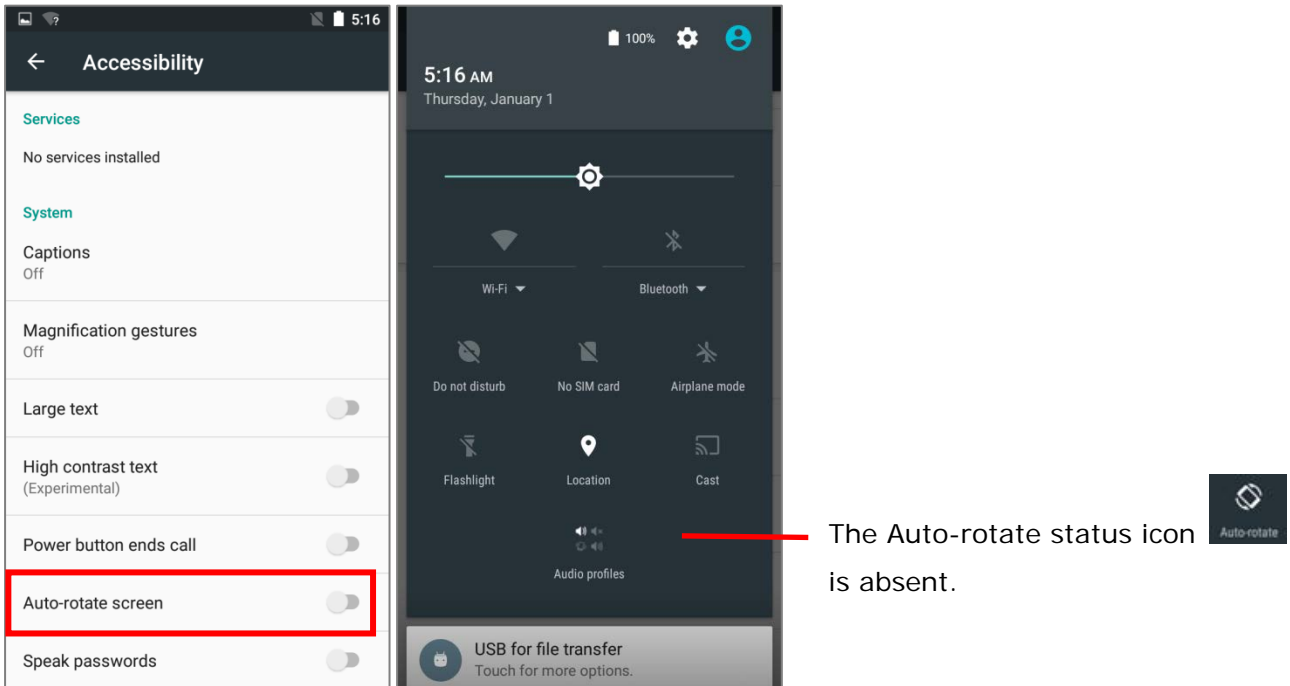

Note:

Auto-rotation is not supported in **Home** screen, **All apps** list and certain applications.

2.3.3. SCREEN TIMEOUT SETTINGS

Tap **All Apps**  | **Settings**  | **Display**  | **Sleep**.

Select the time duration for screen timeout.

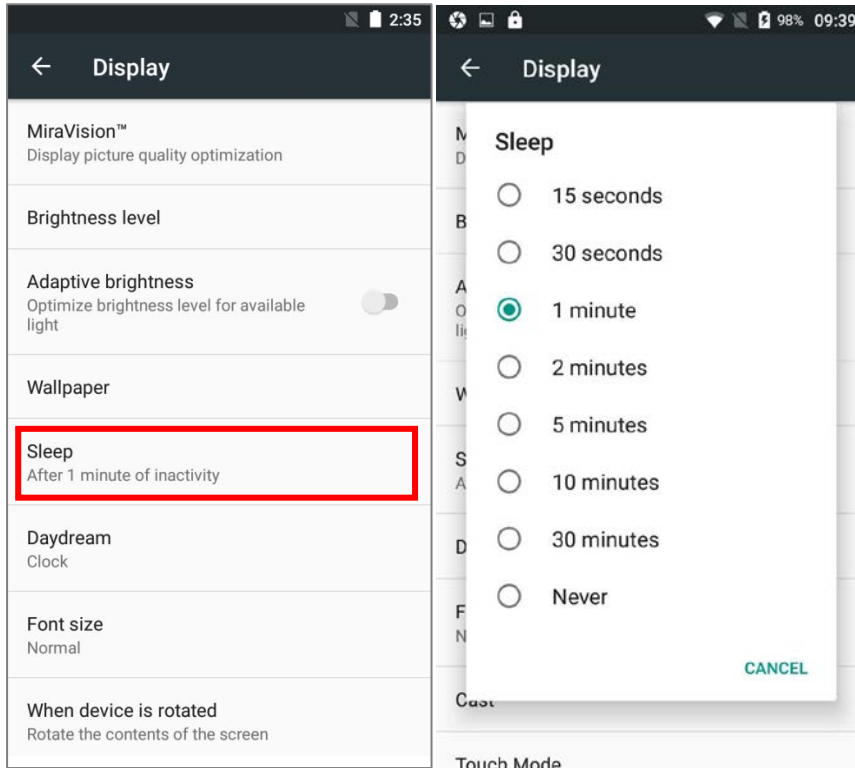

2.3.4. TEXT SIZE

Tap **All Apps**  | **Settings**  | **Display**  | **Font size**. Select the font size between **Small**, **Normal**, **Large** and **Huge**.

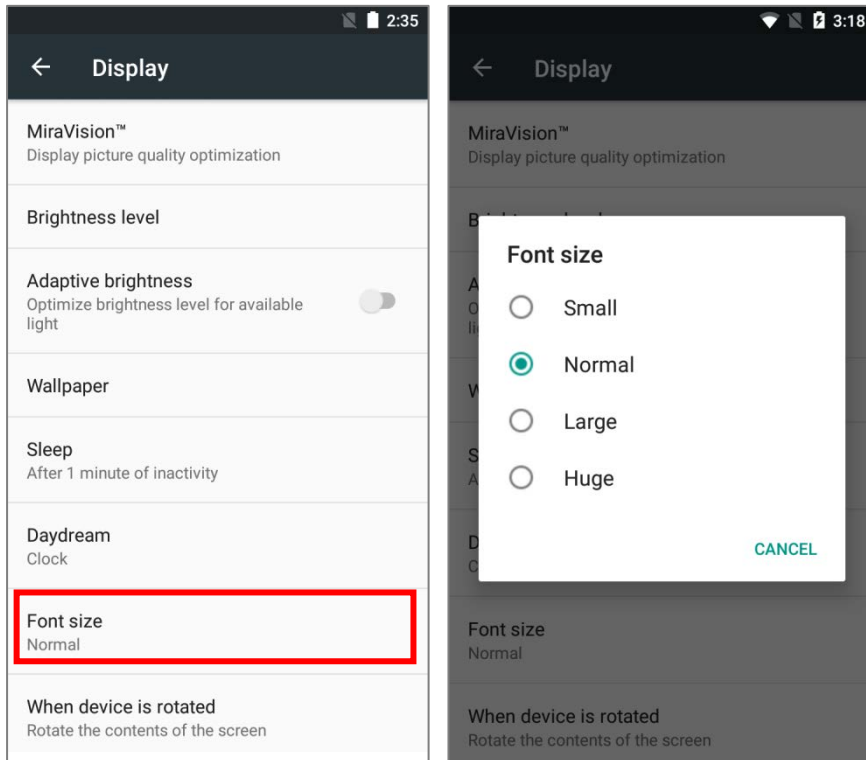

2.4. NOTIFICATIONS

2.4.1. STATUS LED

Two LED indicators located above the touch screen provide information about charging status, scanner light beam, and scanner "**Good Read**" during data collection.



Indicator	Status	Description
Charging	Green, solid	Charging complete
	Red, solid	Charging the mobile computer
	Red, blinking	Charging error (for instance, battery not in place)
Backup battery power being used	Red, solid	Upon the removal of the main battery the red light is on for a while and then goes off to signal that the main battery is ready to be removed.

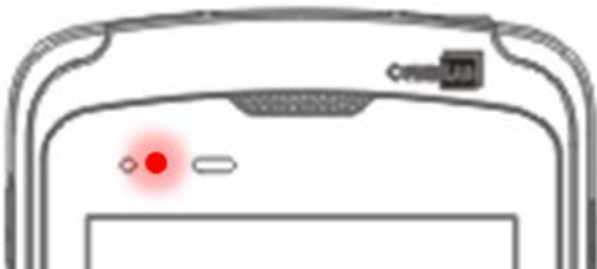

Indicator	Status	Description
Barcode or RFID tag decode	Green, flash once	Good read

Note: For Scanner decode and Scanner beam LED to function, LED notification must be enabled in Reader Configuration.

2.4.2. AUDIO

The speaker is used to play sounds for events, or play audio files. In addition, it can be programmed for status feedback. In noisy environments, you may consider connecting a headset instead. A headset jack is provided on the top of the mobile computer, which is a 3.5 mm DIA stereo earphone jack. The mobile computer also supports using Bluetooth headsets.



Supported audio file formats include: WAV, MP3, AAC, AAC+, Enhanced AAC+, AU (including ADPCM), Midi, XMF, AMR (NB and WB).

Use the volume buttons on the side of the mobile computer to adjust the system volume.

2.4.3. SOUNDS AND VIBRATION

The mobile computer is integrated with a vibrator, which is software programmable for tactile feedback. This can be helpful when working in noisy environments.



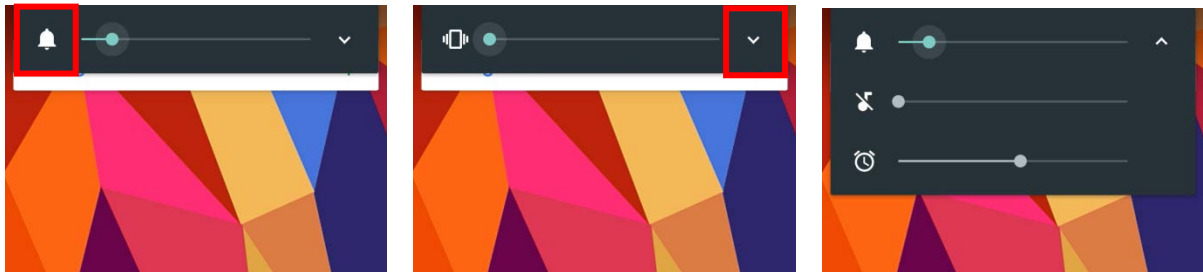

You may also set the mobile computer to vibrate only, in which all system sounds will be muted and replaced by the vibrator.

On any screen, press down **Volume Up** or **Volume Down** key to open quick sound menu. Tap  to switch this device to Vibration mode. To modify specific sound settings, tap  to access more settings.



SOUND PROFILES

You can apply the default sound profiles : **Outdoor**, **Meeting** , **Silent** or **General** (customizable).

Go to **All apps**  | **Settings**  | **Sound & notification**  to select a desired profile. With **General** profile, you can tap on  to customize advanced settings.

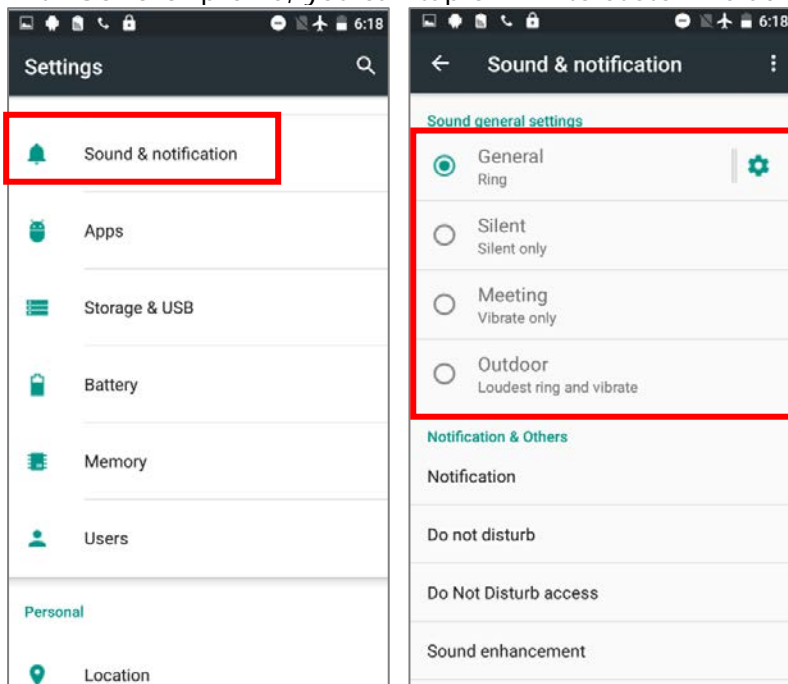

DISABLE UNWANTED NOTIFICATIONS WITH “DO NOT DISTURB”

You can temporarily disable specific notifications (vibration or sound) using **“Do Not Disturb”** in Quick Settings menu. What’s more, you can schedule the duration of the disabled status so that the notifications will switch to enabled state automatically based on your arrangement.

Use your two fingers to swipe down from the status bar to open Quick Settings, tap on **“Do not disturb”** to enable this feature and make further adjustment.

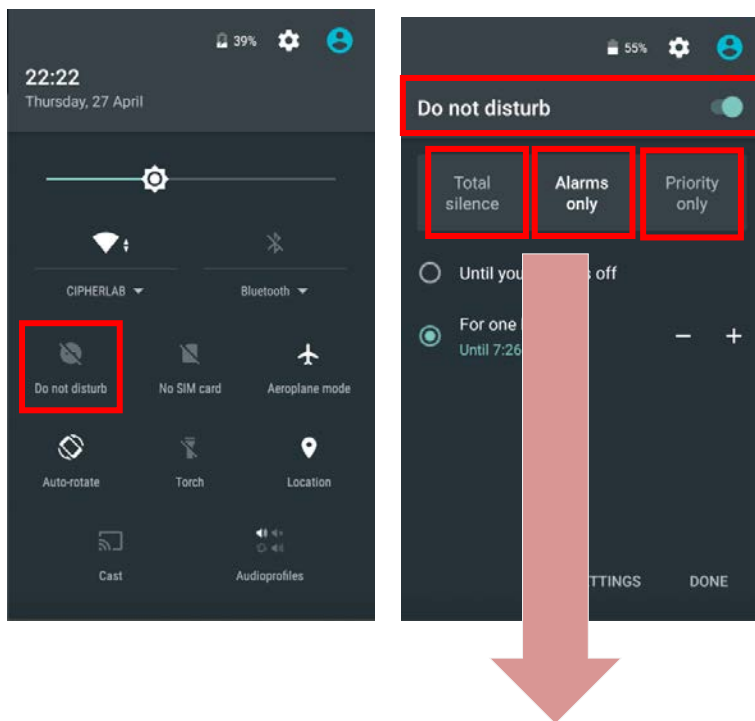



	Total Silence	Alarm Only	Priority Only
Alarm	OFF	ON	ON
Reminders	OFF	OFF	Adjustable (Default: ON)
Events	OFF	OFF	Adjustable (Default: ON)
Incoming Calls	OFF	OFF	Adjustable (Default: From Contacts Only)
Messages	OFF	OFF	Adjustable (Default: OFF)
Music, Video, Game or Media	OFF	ON	ON
In-Call	ON	ON	ON

2.5. DATE AND TIME

2.5.1. SET DATE, TIME AND TIME ZONE

By default, the mobile computer automatically synchronizes the date and time to the WWAN network (if connected).

To set the date and time manually:

- 1) Tap **All Apps**  | **Settings**  | **Date & time** .
- 2) Tap **Automatic date & time** and select **Off** to disable using network-provided time.
- 3) Deselect Automatic time zone.
- 4) Tap **Set date**. Use the sliders to select the correct month, date and year. Tap **OK** to save.
- 5) Tap **Set time**. Tap the clock to select the correct time. Tap **OK** to save.
- 6) Tap **Select time zone**. Select the correct time zone from the list.

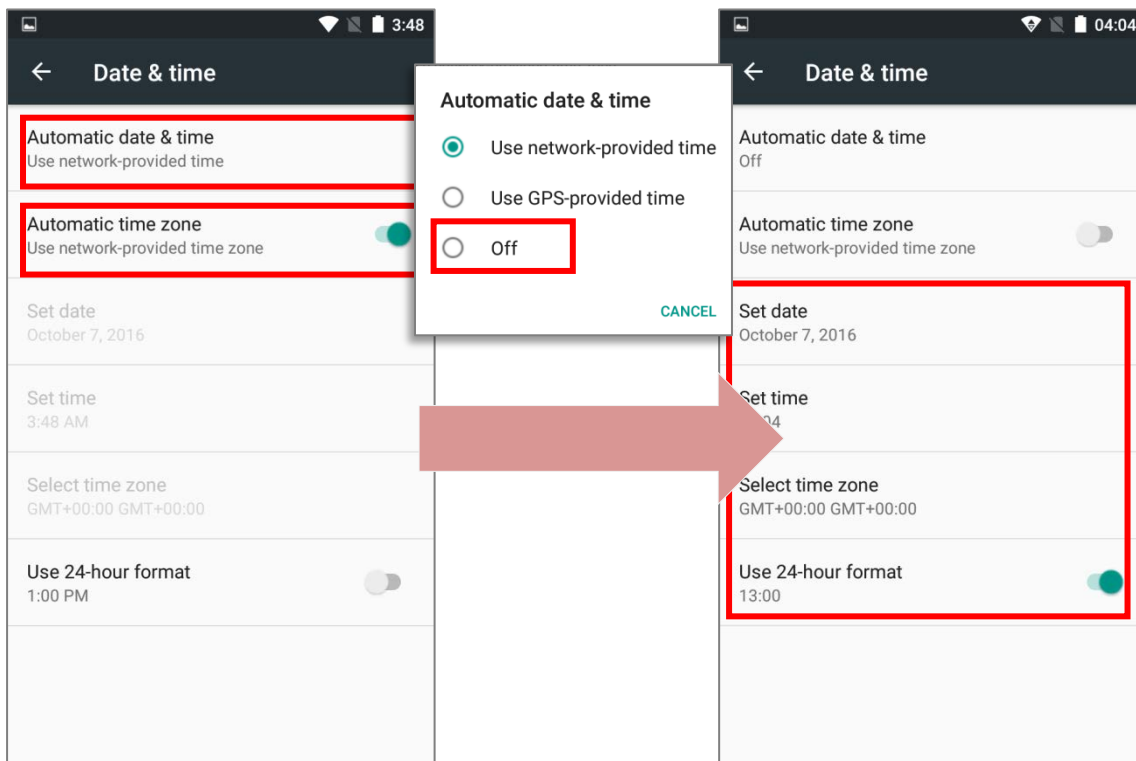

AUTOMATIC DATA & TIME

You can have this device automatically synchronize with a designated NTP server:

1) Tap Automatic data & time and select Use network-provided time.

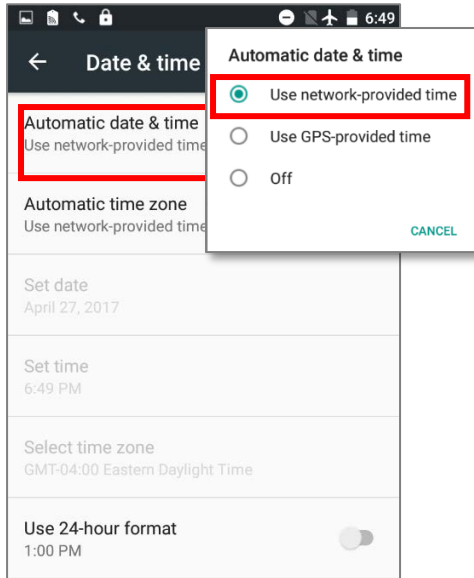

2.6. LANGUAGE & KEYBOARD INPUT

Tap **All Apps**  | **Settings**  | **Language & input**  to change the system language, default keyboard type, and configure keyboard input and speech settings.

2.6.1. CHANGE DISPLAY LANGUAGE

On the **Language & input** screen, tap **Language** and then select your desired system language, the new setting will immediately be applied after your selection.

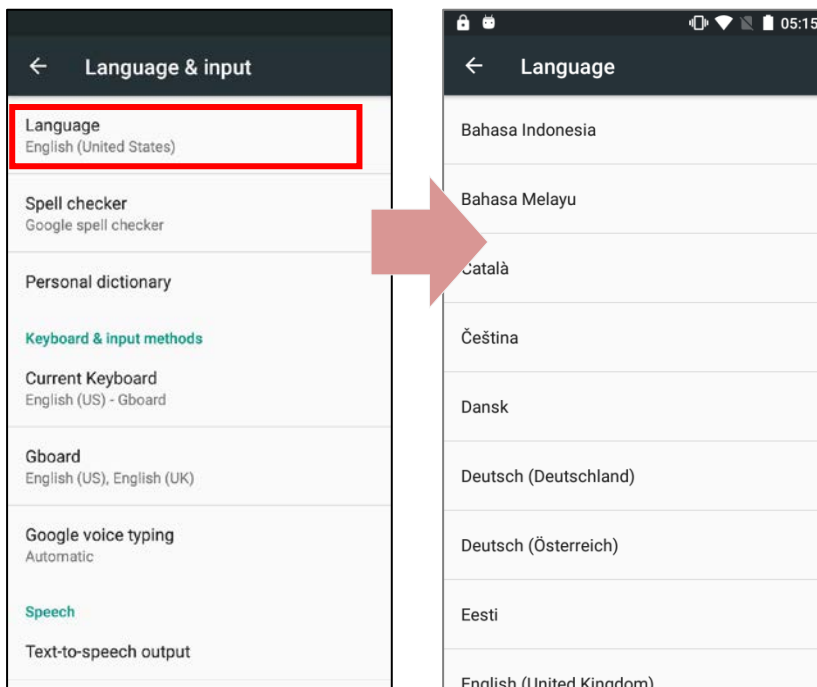

2.6.2. ON-SCREEN KEYBOARD

Tap a text input field to automatically open an on-screen keyboard. The virtual keyboard will vary depending on the data type (text or numbers) this field requires.

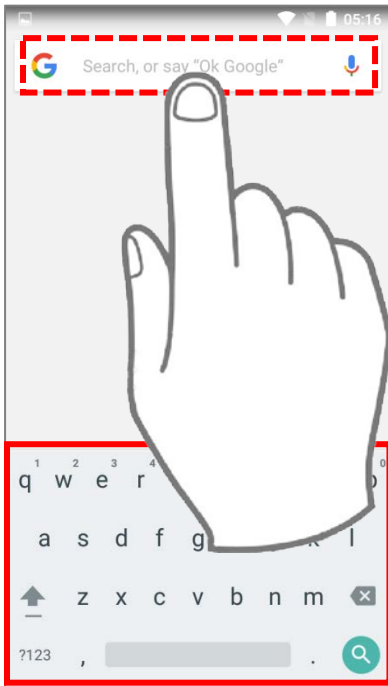

SELECT KEYBOARD (INPUT METHOD)

On the **Language & input** screen, select **Current Keyboard** to change your current keyboard or manage the selectable keyboards by entering "**CHOOSE KEYBOARDS**" and enable the input methods you need.

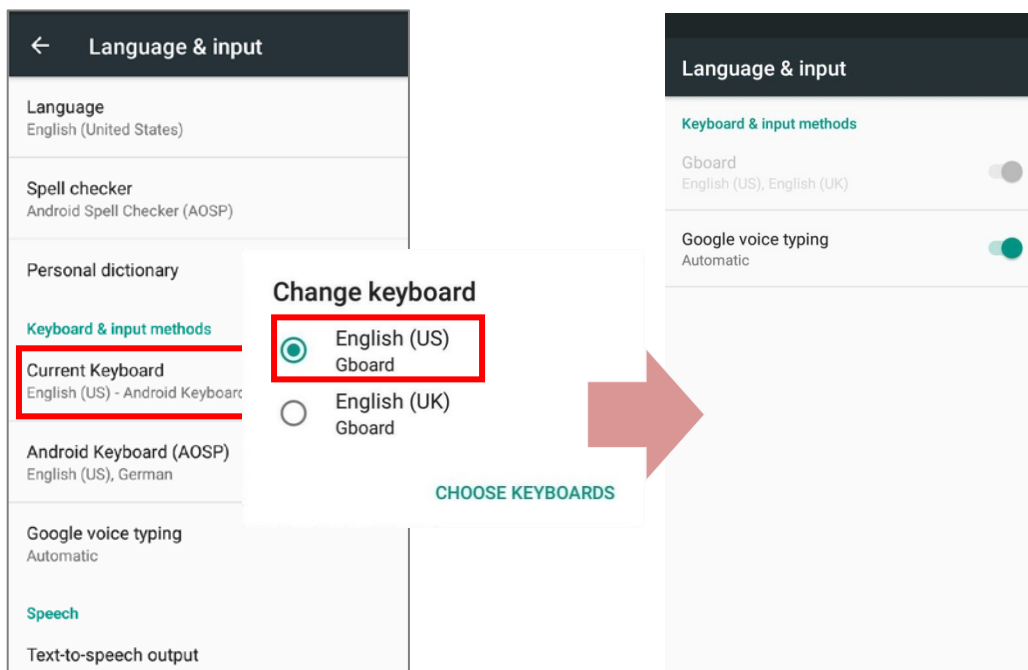

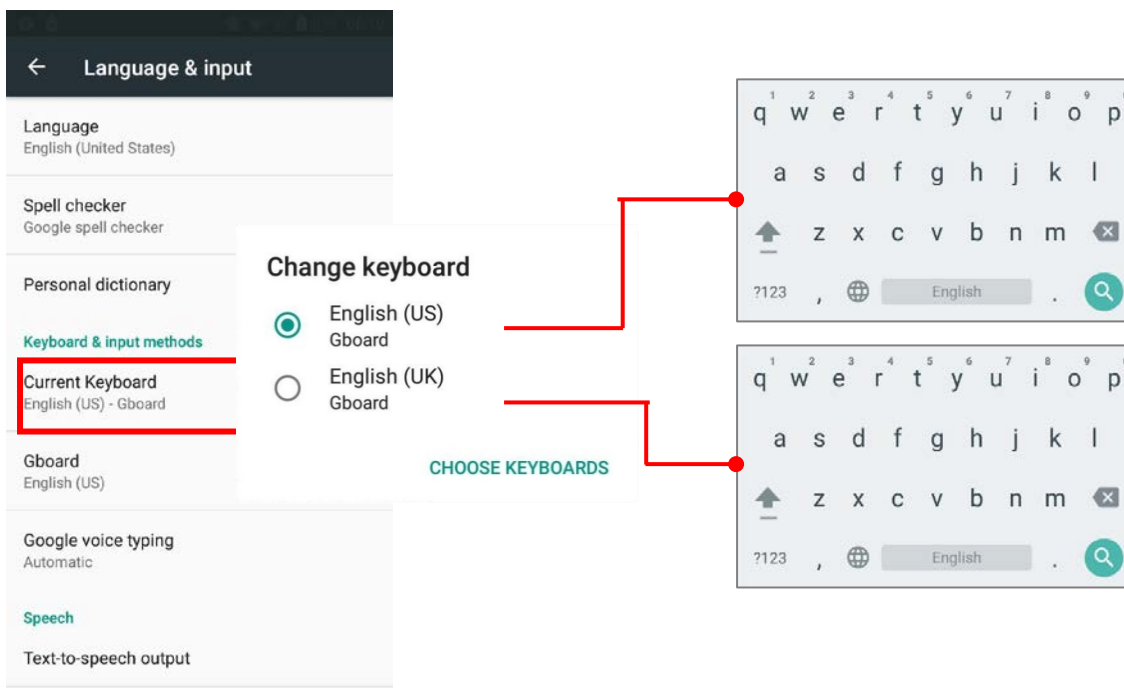
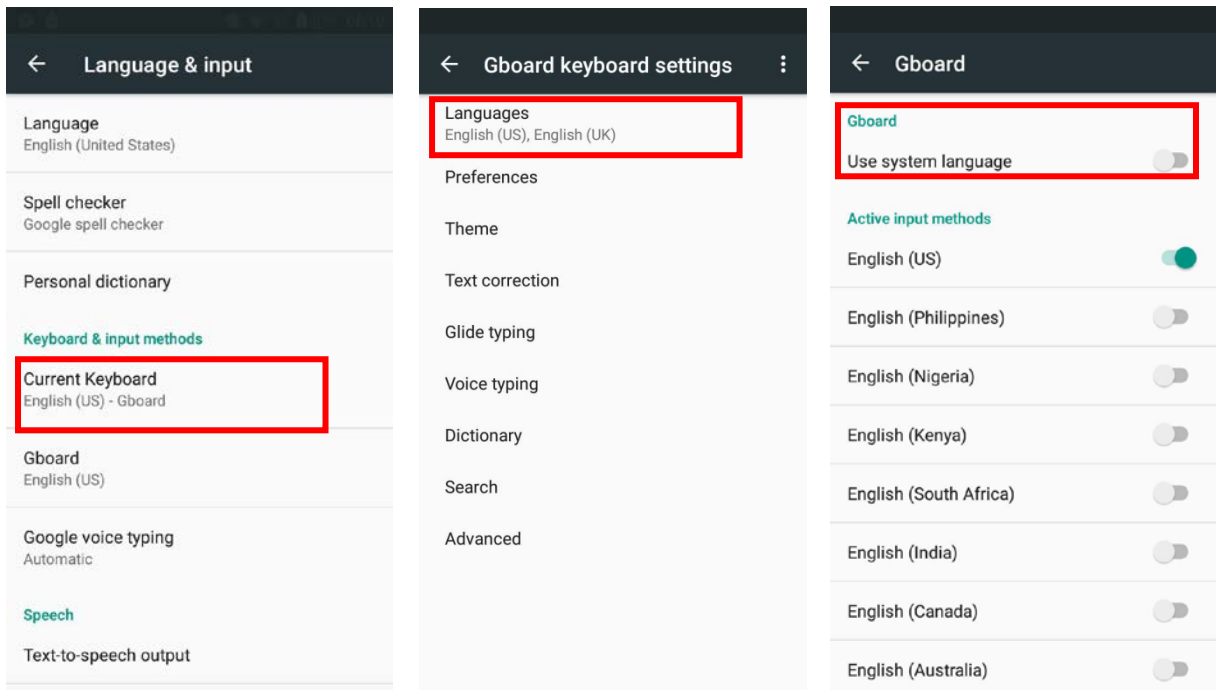

Android provides a variety of keyboard layouts of different languages. To have more options of key layouts, for example, English (UK), you can:

- 1) On **Language & input** screen, select **Gboard** and then **Languages**.
- 2) On the list, disable **“Use system language”**.
- 3) Select your desired language keypad layouts.
- 4) Return to **Language & input** screen, and your **Current Keyboard** now has more options.



ADJUST KEYBOARD SETTINGS

To configure keyboard settings, tap and hold the comma button  until a settings button  appears. A menu will open, allowing you to adjust input language (if you would like to use an input language different from the system language) or keyboard settings.

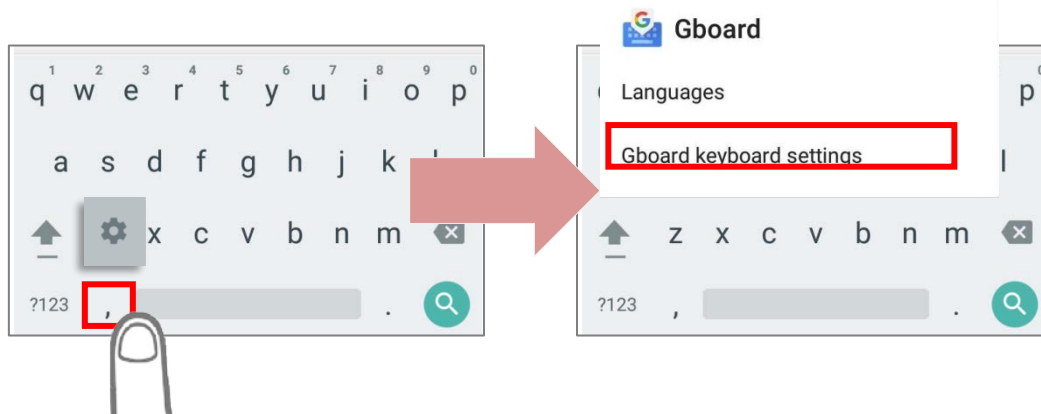

By tapping **Gboard Keyboard Settings**, you can further adjust the settings to suit your needs.

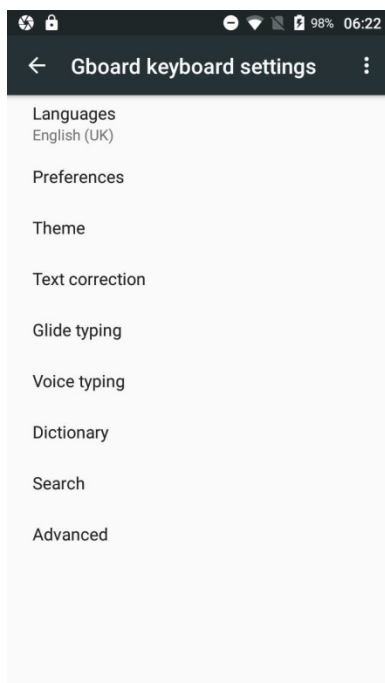

CHANGE KEYBOARD (INPUT METHOD)

The input methods you enabled in **Current Keyboard** under **Language & input** are available by tapping  on the on-screen keyboard. To use other input methods, simply tap it to cycle through the options.

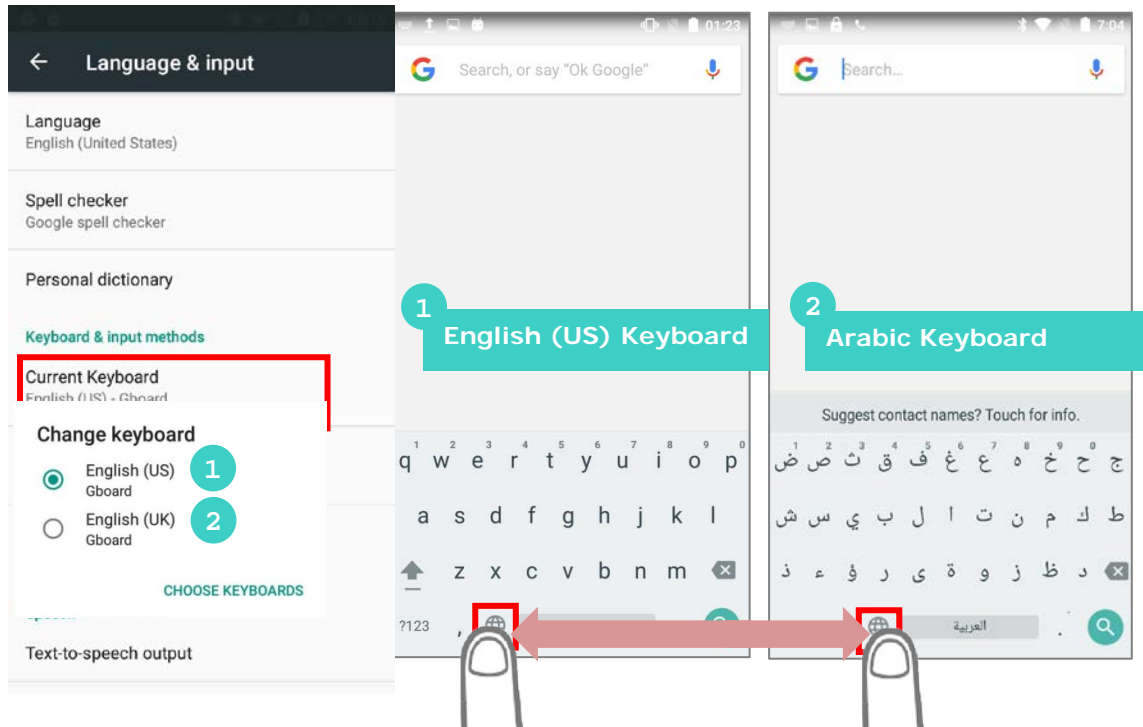

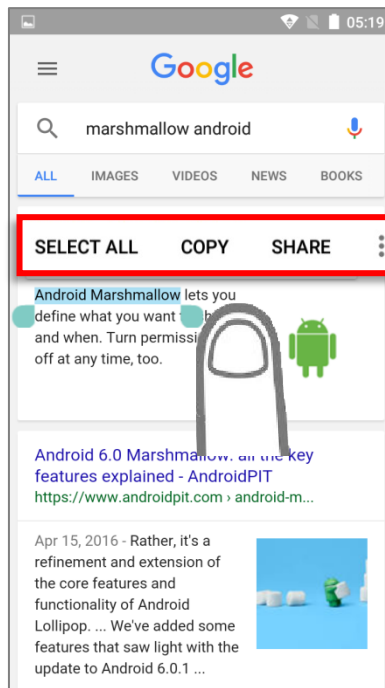

EDIT TEXT

Tap and hold text on the screen to enable a text editing menu for selecting all text, or copying and pasting text within or across applications. Some applications may use different ways to select or edit text.



ENTER NUMBERS AND SYMBOLS

The appearance of the switch button to numeric or symbol keyboard may vary; the example below demonstrates how to use the switch key to access your desired numeric or symbol keyboards from the default **Gboard** keyboard. To enter **Numeric / Symbol** keyboard, tap . On **Numeric / Symbol** keyboard, tap  to access more symbols or tap  to return to the **Gboard** keyboard.

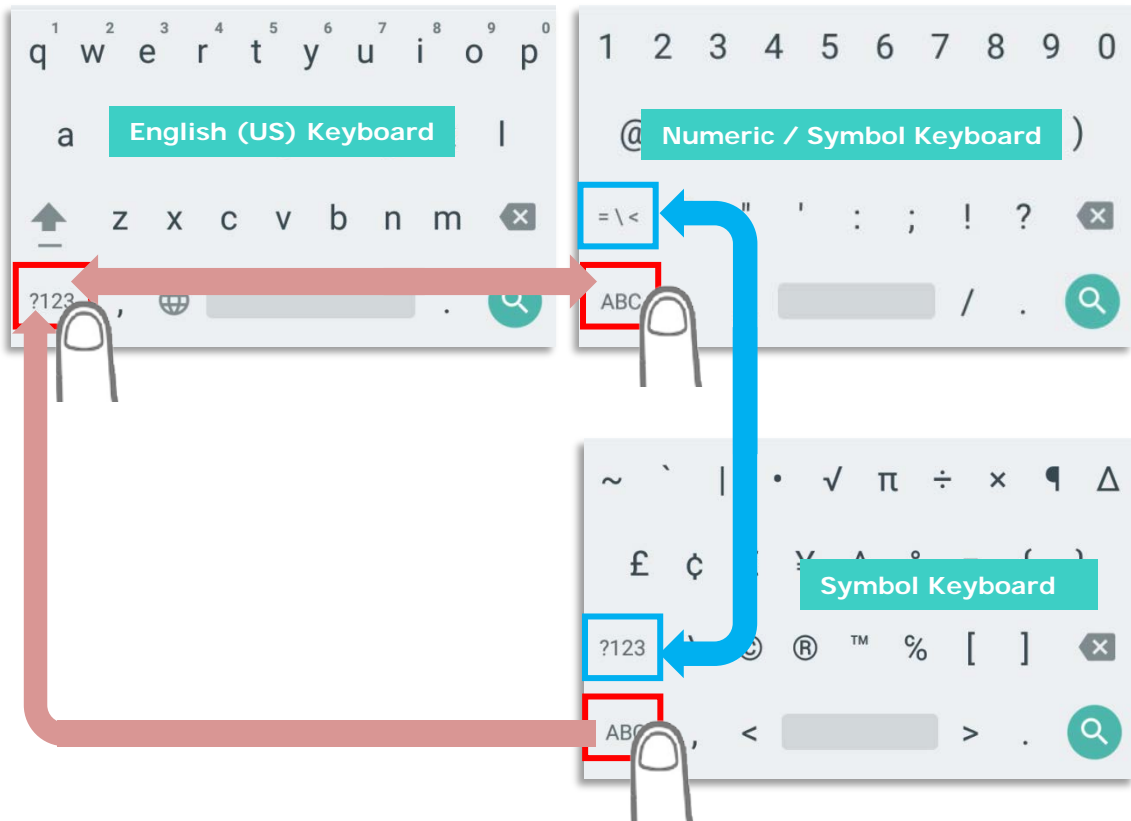

On **Gboard** keyboard, you can input number or symbols without switching to **Numeric / Symbol** keyboard.

- ▶ Tap and hold the period button  to open quick symbol keyboard.
- ▶ Tap and hold a letter from **q~p** on the top row to bring up the specific number key.

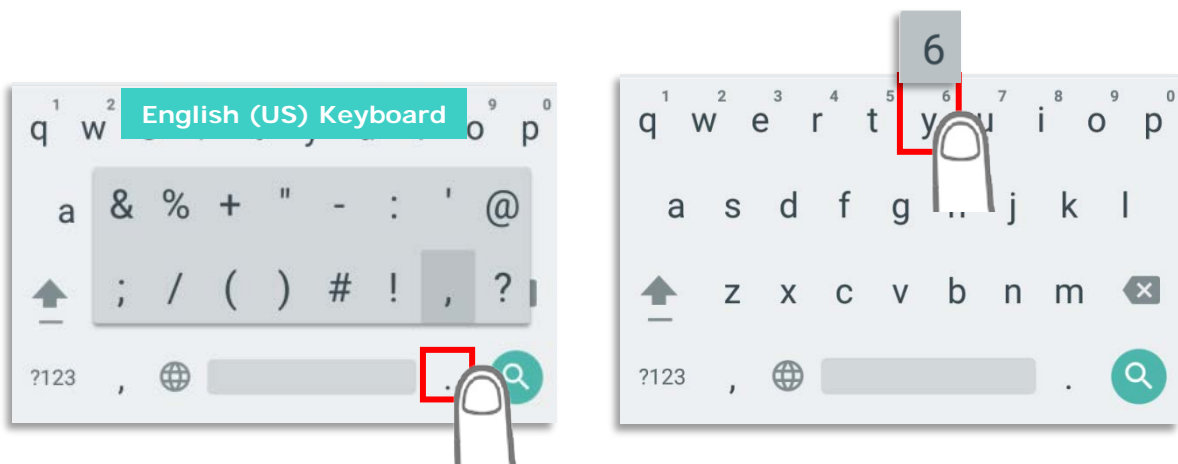

ENTER UPPERCASE LETTERS

Tap and hold the Shift key  , and tap a character key to enter an uppercase letter. The letters will return to lower case once an uppercase letter is entered.

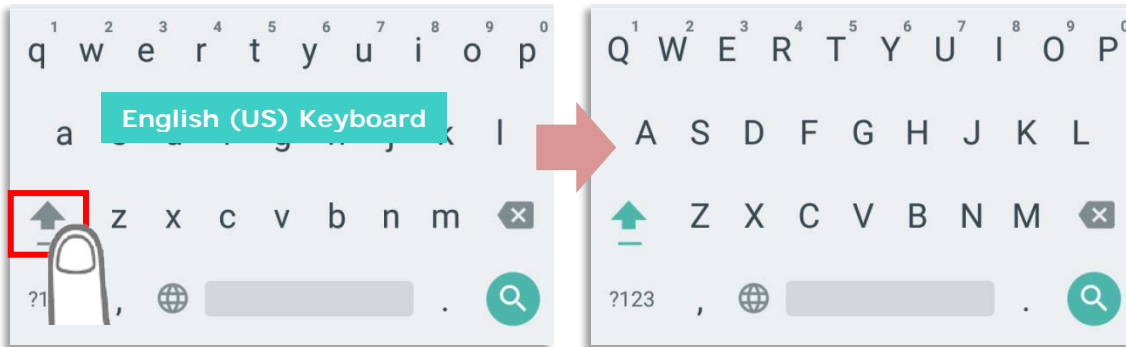

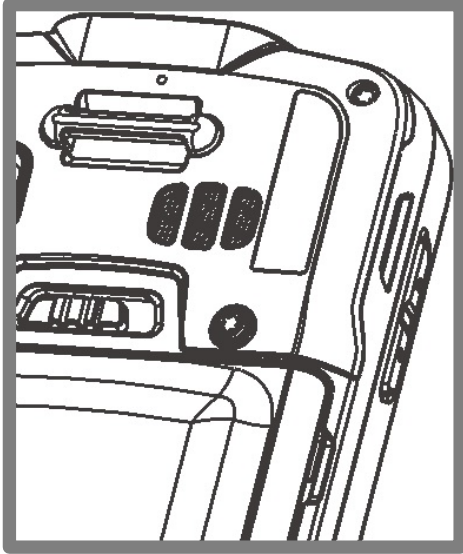

2.7. SOUND AND VOLUME

Use the volume buttons on the left side of the mobile computer to adjust system and ringer volume.



2.8. PROGRAMMABLE KEYS

Use the volume buttons on the left side of the mobile computer to adjust system and ringer volume.

Tap **All Apps**  | **Settings**  | **Programmable keys**  to assign specific functions to the four programmable keys: volume up, volume down, and the left and right function keys (side keys).

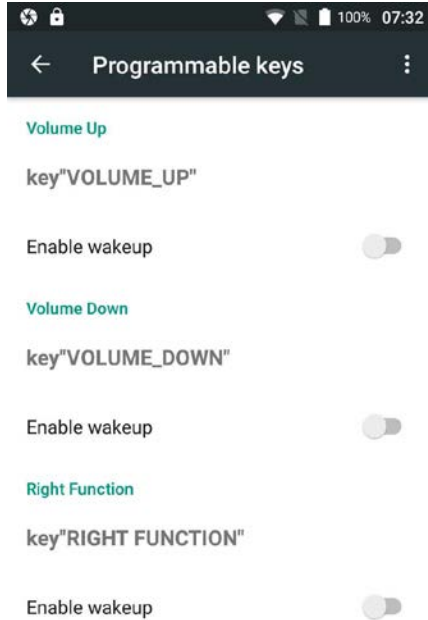

After redefining the programmable keys, the changes will immediately take effect.

ENABLE WAKEUP

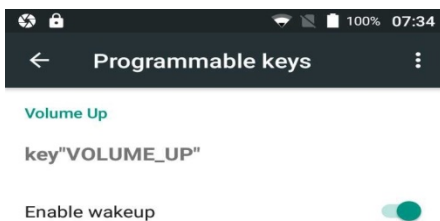

Select the **Enable wakeup** to enable pressing the key to wake the mobile computer from suspend mode.

Note:

This selection is automatically disabled if an application is selected for the key on the **Apps** tab page.

ASSIGN KEYCODE

Tap the key you would like to assign. A screen opens showing a list of available keycodes or applications. On the **Keycodes** tab page, scroll down to view the entire list of keycodes, and tap a keycode to apply.

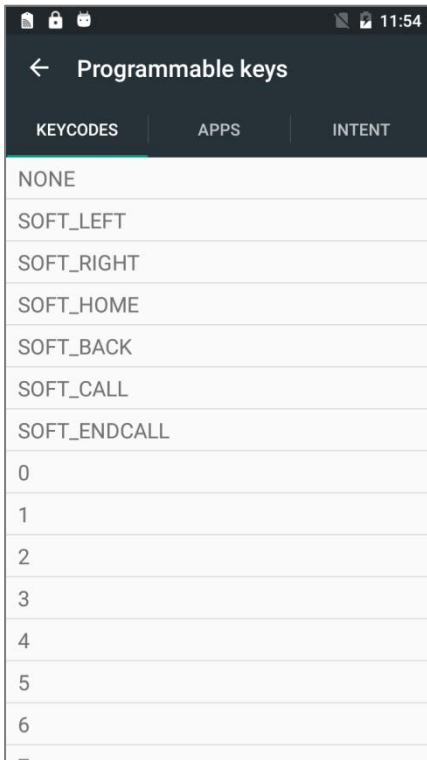

ASSIGN APPLICATION

Tap the key you would like to assign. Tap the **Apps** tab page to open a list of available applications. Scroll down to view the entire list of applications, and tap an application to apply.

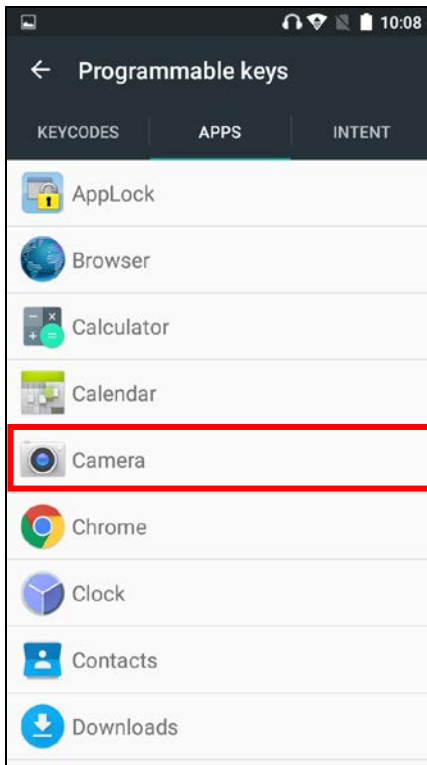

After an application is selected, an icon will appear next to the assigned key. Also, the **Enable wakeup** checkbox will be automatically disabled.

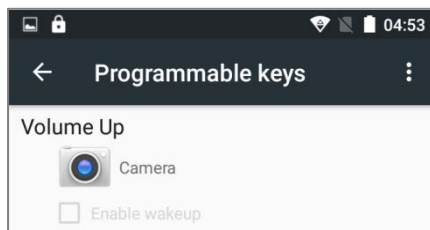

ASSIGN INTENT

You can make use of the **intent** (the specific intent string should be input beforehand in the configuration xml file on your device) to assign a hardware key to launch a specific application. When you press this hardware key, this App will be launched by this intent. On the **Intent** screen, input the name of the Intent and then tap on **“Commit”**.

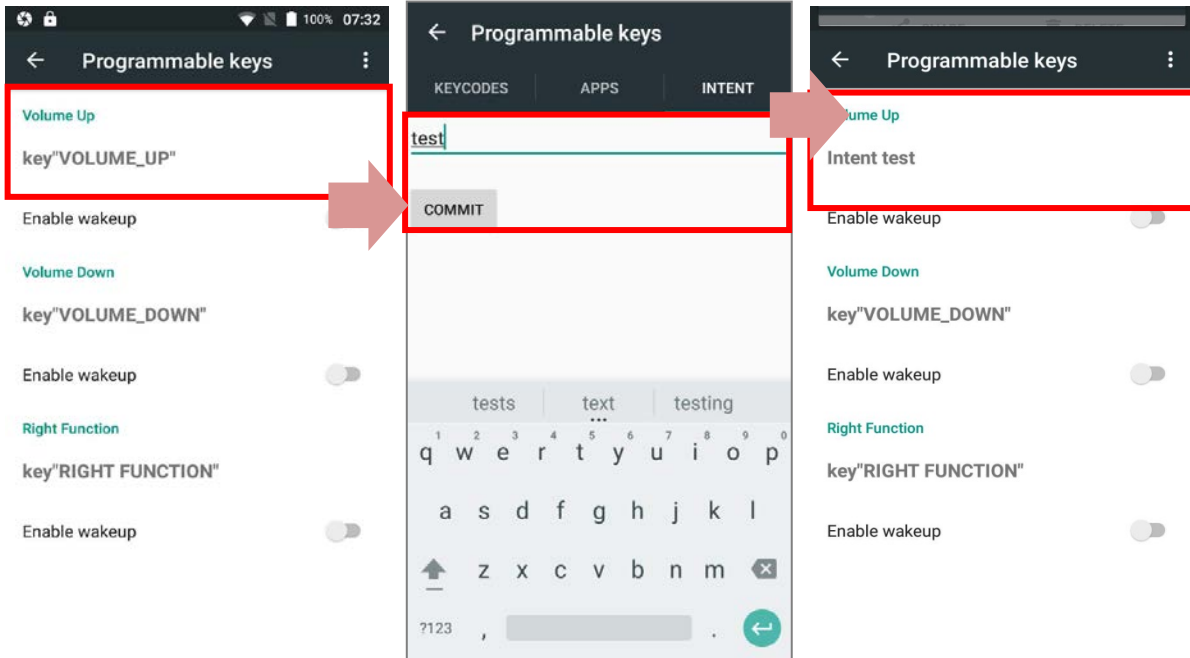

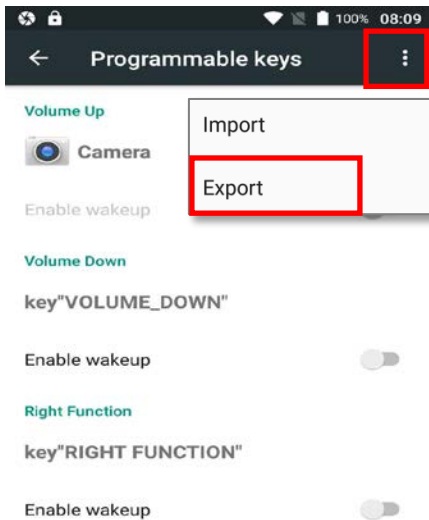

IMPORT AND EXPORT SETTING

After finishing configuring the keys, you can save the setting to a **txt** (XML format) file, allowing you to apply the same setting to other devices. To do this, tap **More**  and then **Export**. This file will be exported to the root folder of the device's internal storage as **keys_config.txt**.

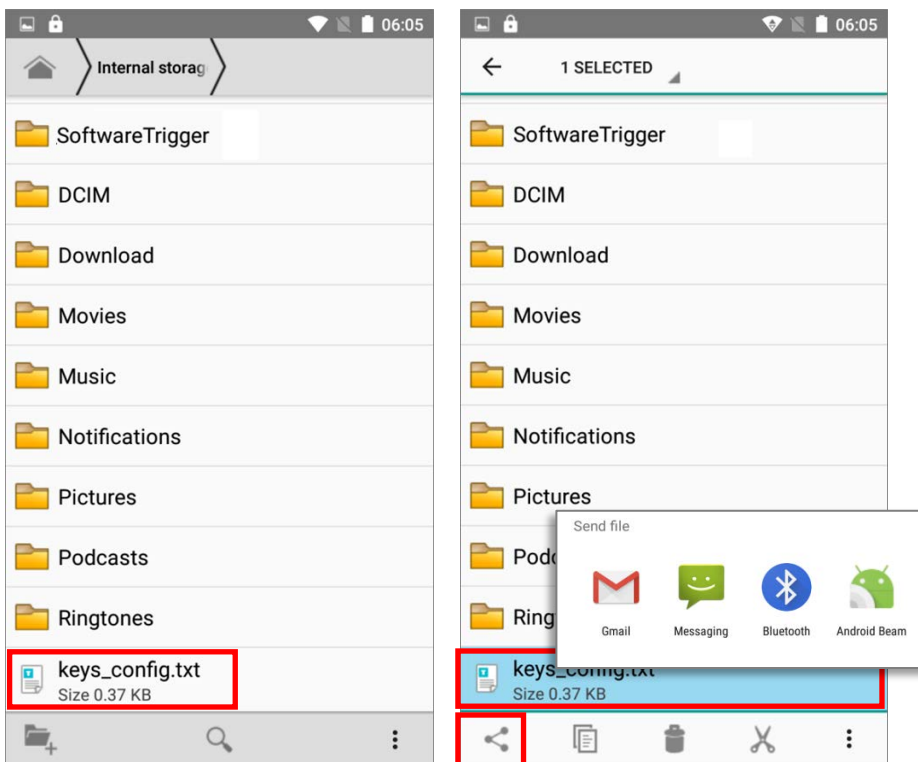

To share this file with other devices, tap and hold the file name; tap **share**  to select a file-sharing method from **Send file** menu. Please make sure the filename is not renamed.



To import the configuration file to be used in **Programming keys**, make sure the file is saved in the root folder of the device's internal storage with the file name **keys_config.txt**. On the **Programming keys** screen, tap **More**  and then **Import**. The new setting will be immediately applied to the keys.

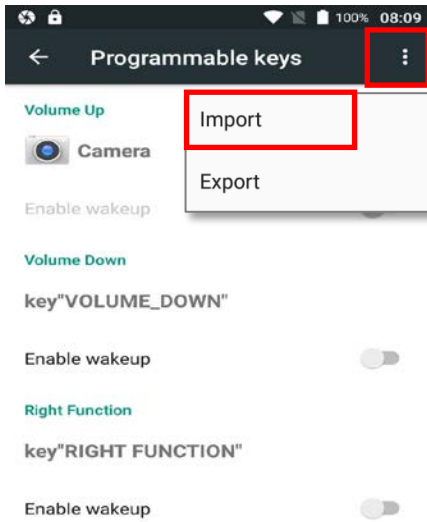

2.9. DATA CAPTURE

2.9.1. BARCODE READER

A selection of scan engines is available for delivering flexibility to meet different requirements. Depending on the scan engine integrated, the mobile computer is capable of scanning barcodes of a number of symbologies that are enabled by default while running the ReaderConfig application. If you need to scan barcodes that are encoded in a different symbology, enable the symbology first.

2.9.2. DIGITAL CAMERA

An integrated 8 megapixel rear camera in the mobile computer is specifically designed for collecting image data. You may use the image capture utility to turn on the camera and capture images. By default, the images taken by this camera application are saved as JPG files in the **DCIM** folder in the device's primary storage.

BASIC OPERATION

This chapter describes the basic skills to work with the RS50 mobile computer, for instance, on how to operate the home screen, check system statuses and manage notifications. The add-on utilities for applications regarding data collection, processing, and transmission are introduced in the following chapters.

IN THIS CHAPTER

- 3.1 Home Screen..... 79
- 3.2 Status Bar..... 88
- 3.3 Manage Applications..... 93
- 3.4 Suspend & Lock 96
- 3.5 OS Update 98
- 3.6 Back up Your Data 100
- 3.7 Reset to Factory Default 101

3.1. HOME SCREEN

When the mobile computer is fully charged, press the Power key for three seconds to turn on the mobile computer. A locked screen will appear. Slide the lock button  in either direction to unlock the screen.

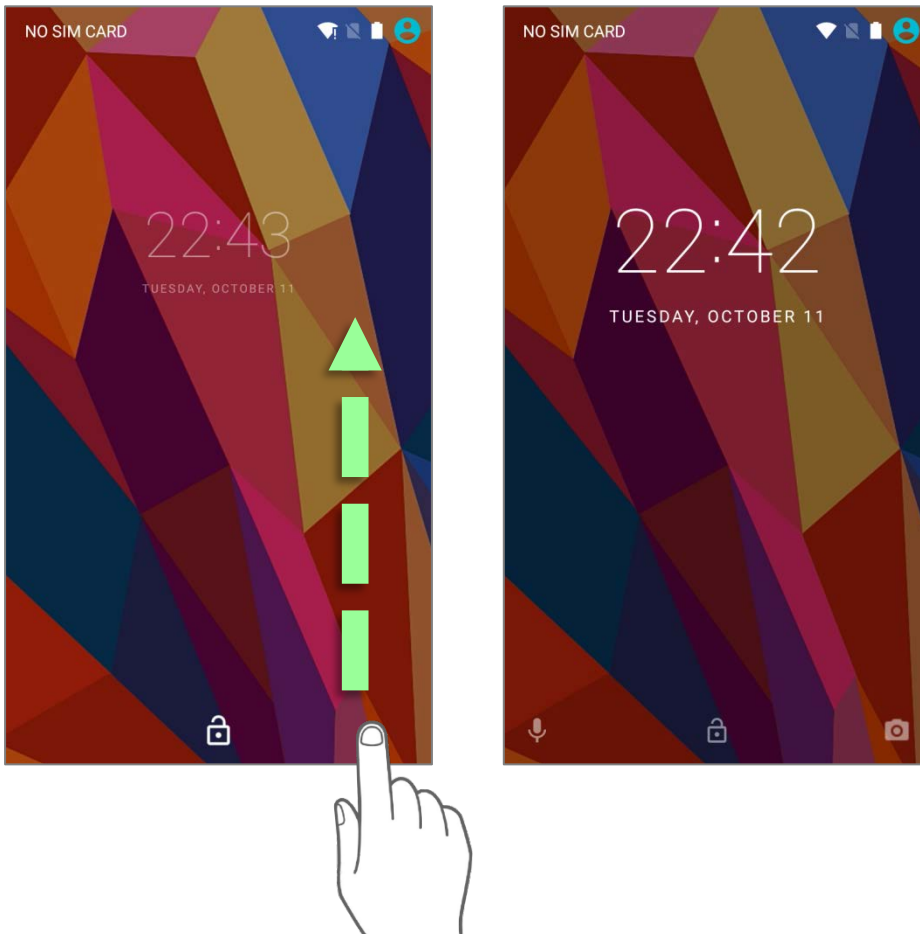

The **Home Screen** appears showing a status bar, shortcut icons, and a dock bar containing an **All Apps** button. The home screen allows multiple pages for placing shortcut icons and widgets. You may customize the home screen according to your preferences.

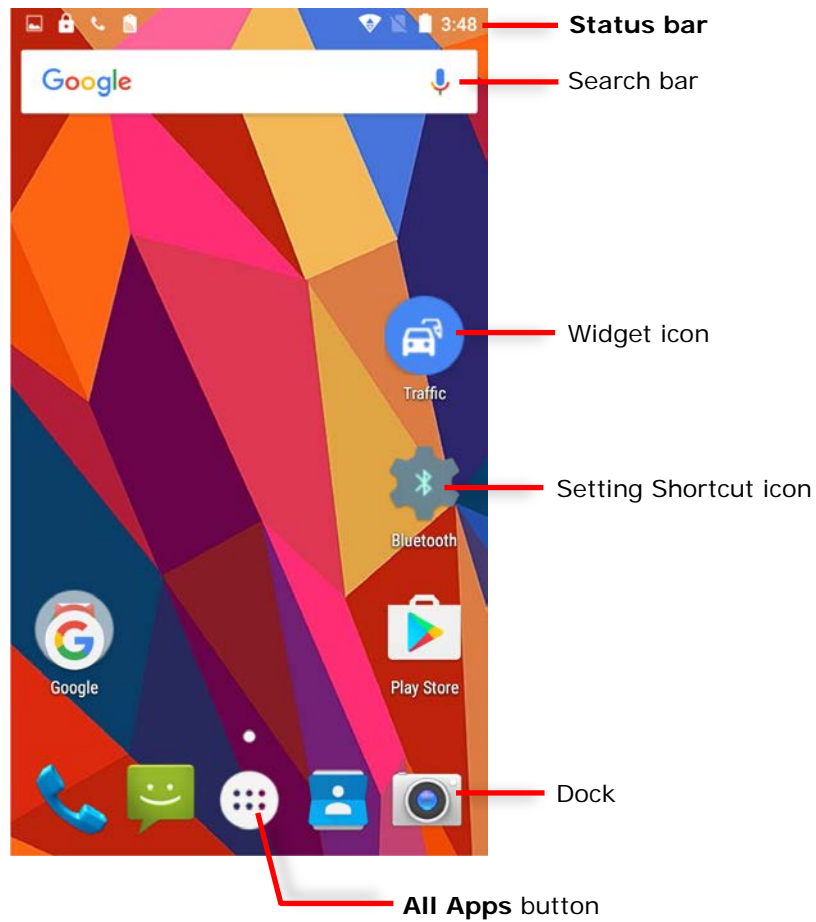

3.1.1. CUSTOMIZE HOME SCREEN

ADD APPLICATION SHORTCUT TO HOME SCREEN

- 1) On the home screen you would like to customize, tap **All Apps** .
- 2) Locate the application to add, tap on and hold the application icon.
- 3) The home screen will appear. Drag the application icon to your preferred position and release to have it placed.

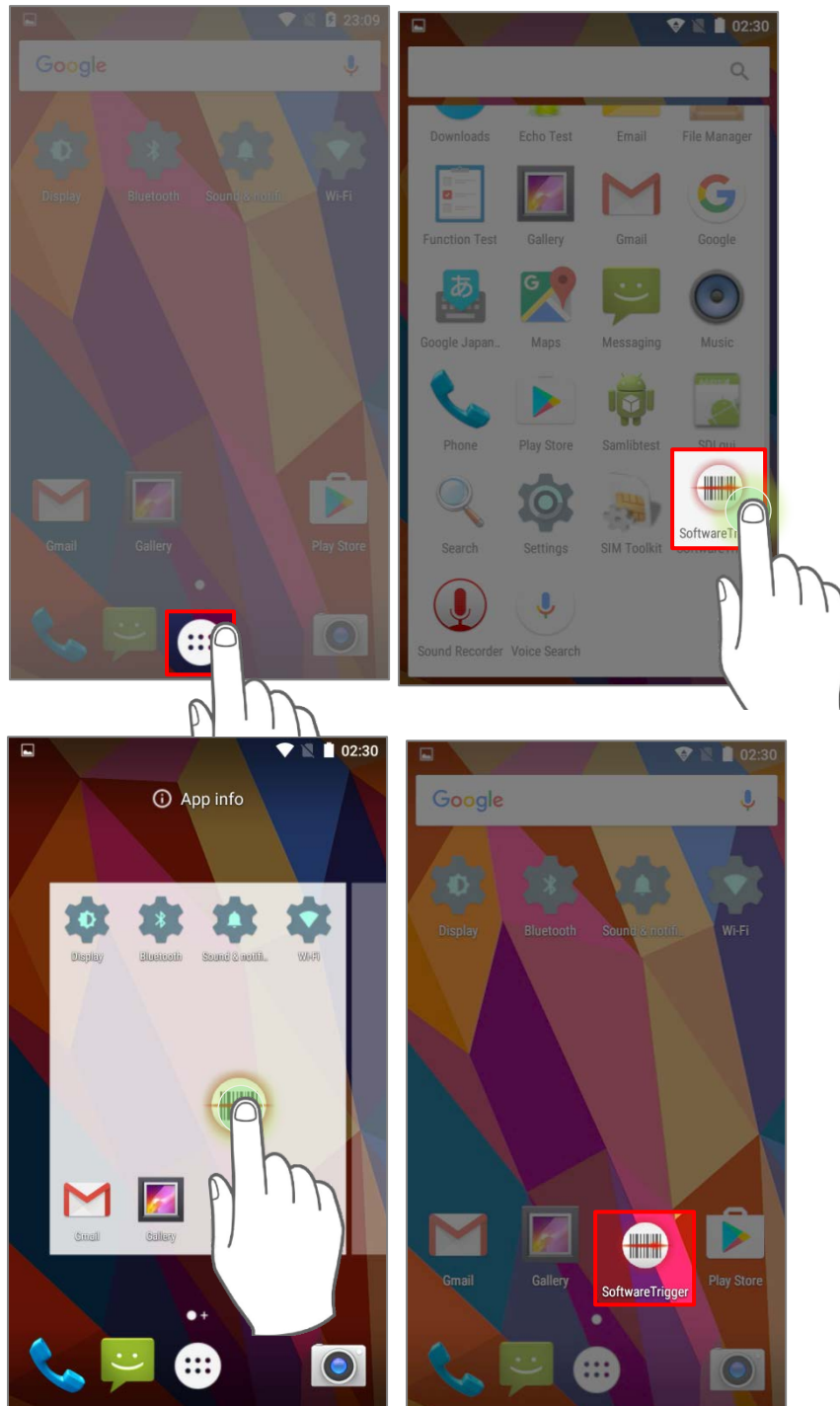

ADD WIDGET TO HOME SCREEN

- 1) Tap and hold any empty spot on the home screen.
- 2) The current layout will shrink, and the available options related to home screen appear on the bottom. Tap **Widgets** to enter the widget selection list.
- 3) In the widget selection list, scroll to locate your desired widget.
- 4) Tap and hold the widget until the home screen layout appears. Drag the widget to your preferred position and release to have it placed. For a setting shortcut, you will have to select a specific setting from the shortcuts list.

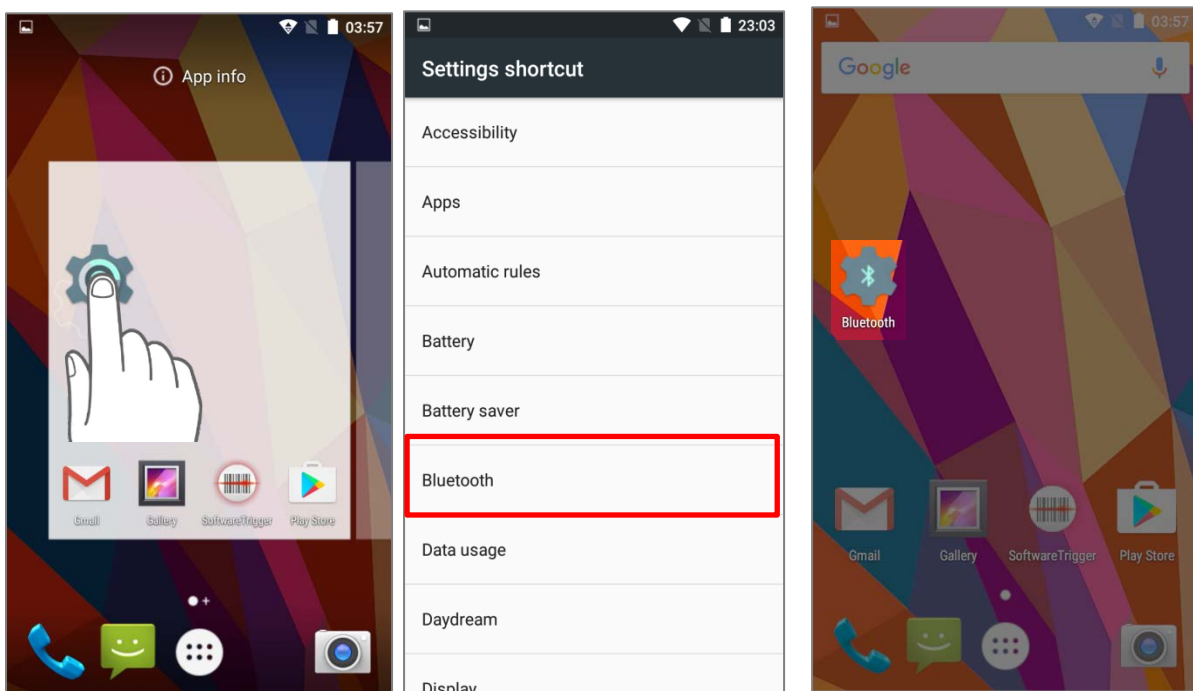
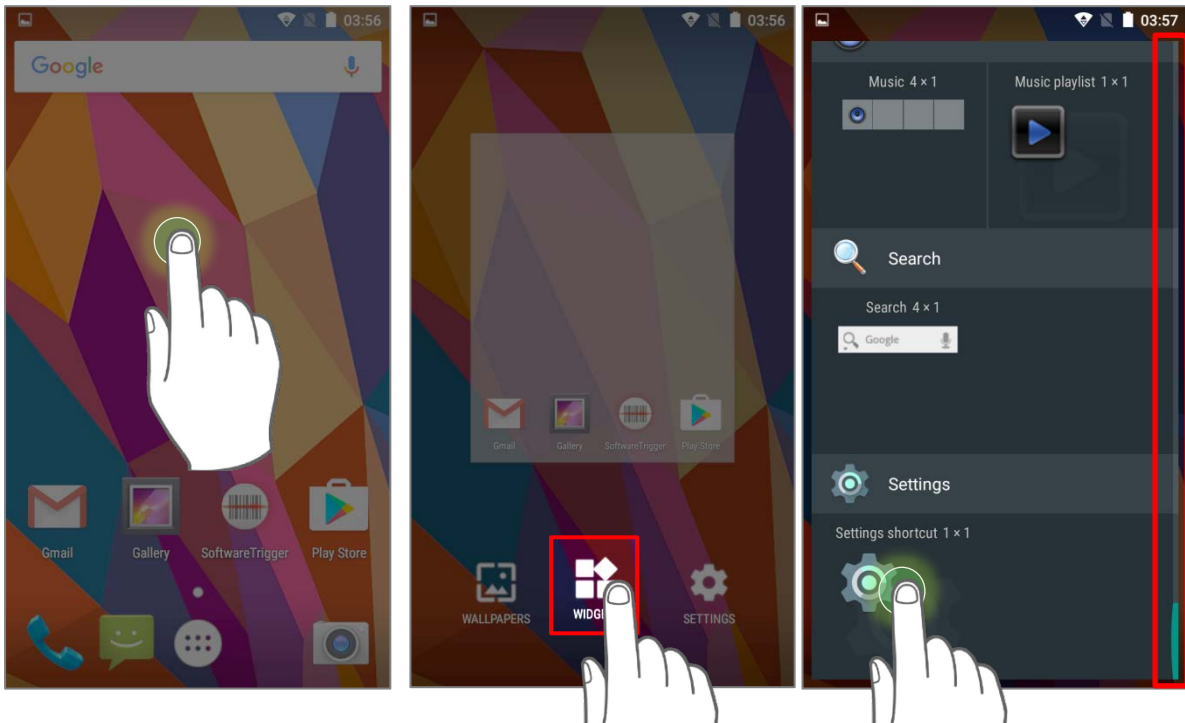

ARRANGE THE SHORTCUTS AND WIDGETS ON HOME SCREEN

- 1) To move or remove a shortcut/widget, on the home screen you would like to customize, tap and hold it to enter layout edit mode, a floating option “**X Remove**” will appear on top of the screen, to which you can drag the unwanted shortcut to remove it. Drag the icon to the preferred position and release it to have it placed.

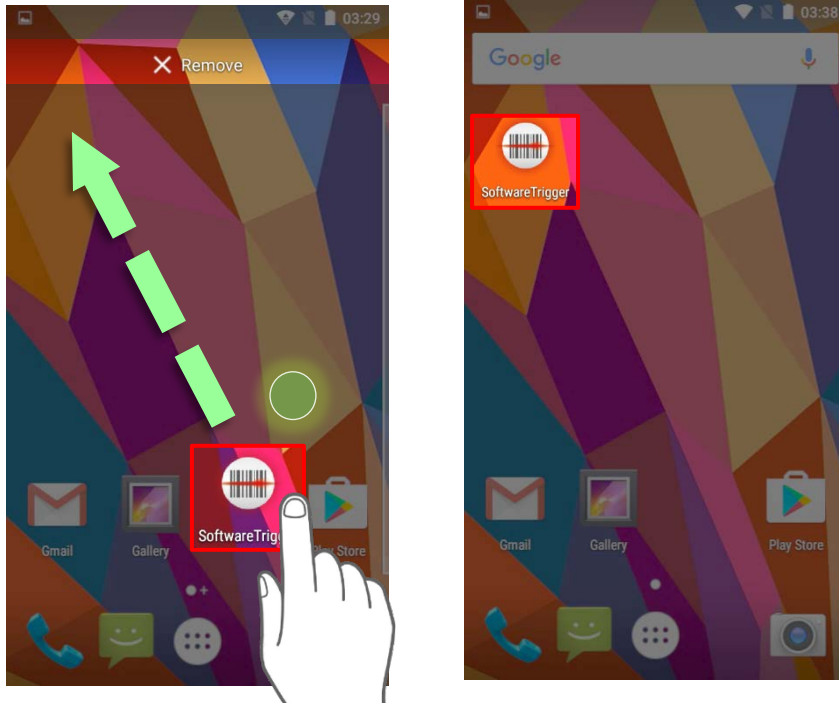

- 2) To resize a widget, tap and hold it until a white frame appears. Tap and drag a white dot to re-scale the widget.



CHANGE HOME SCREEN WALLPAPER

- 1) Tap and hold any empty spot on the home screen.
- 2) Tap **Wallpapers** in the menu that appears.
- 3) Select an image to apply as the wallpaper.
- 4) Tap **Set wallpaper** at the bottom of the wallpaper preview screen to apply it.

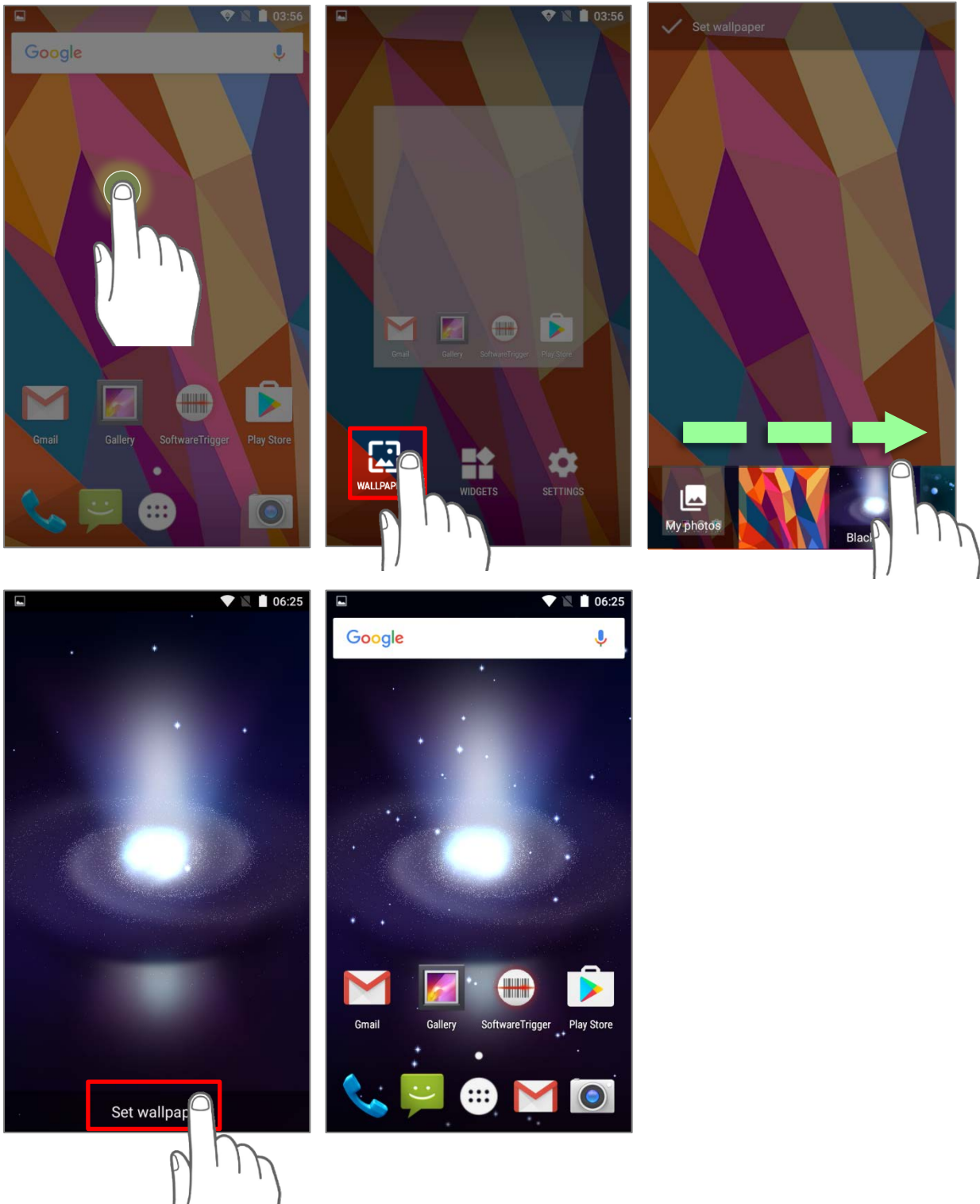

CREATE FOLDER

- 1) On the home screen you would like to customize, tap and hold the application shortcut you would like to move, drag the icon on the top of another icon to create a folder.
- 2) As these icons overlap, a folder is created.
- 3) After you let go your finger, these icons are enclosed in a circle.

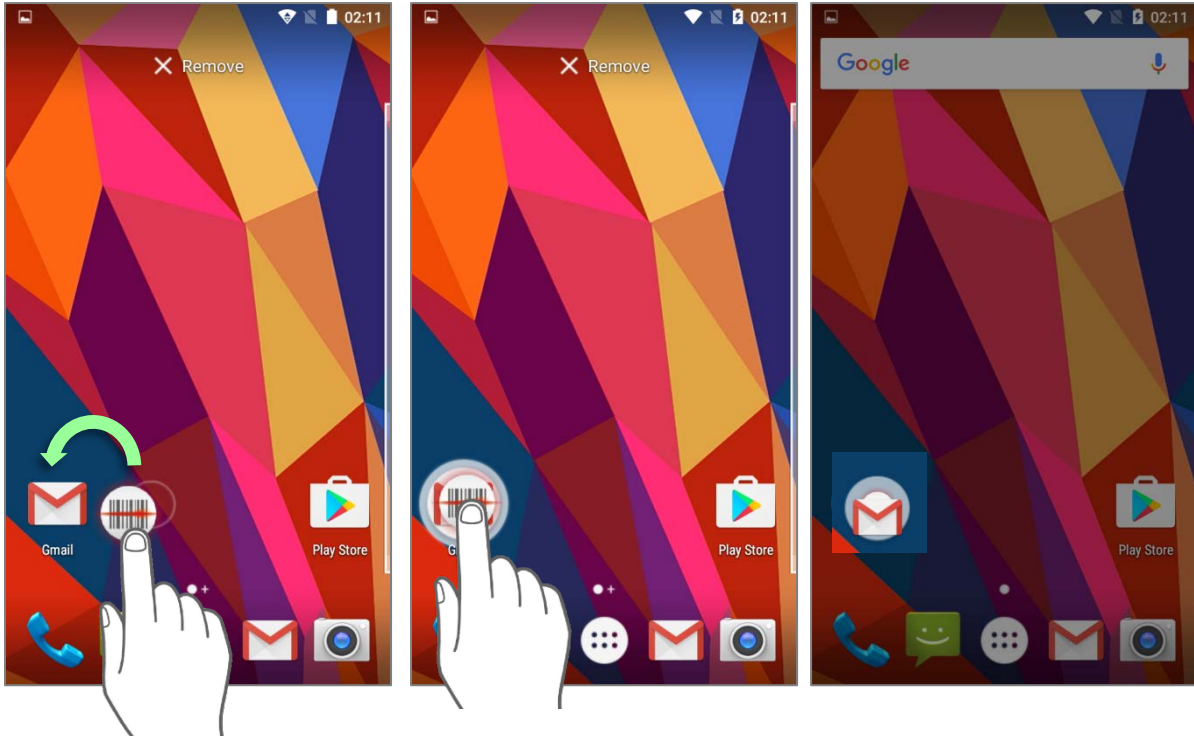

NAME A FOLDER

- 1) Tap the folder you would like to name.
- 2) The folder will expand from a small circle to a full rectangle to show all the shortcuts in it. Tap **“Unnamed Folder”** and edit the folder name.
- 3) Tap **Done**  on the on-screen keyboard.
- 4) Tap elsewhere on the screen, the folder will shrink to a small circle with its new name.

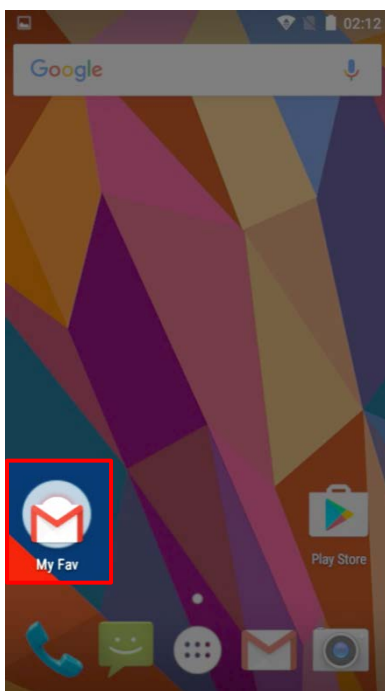
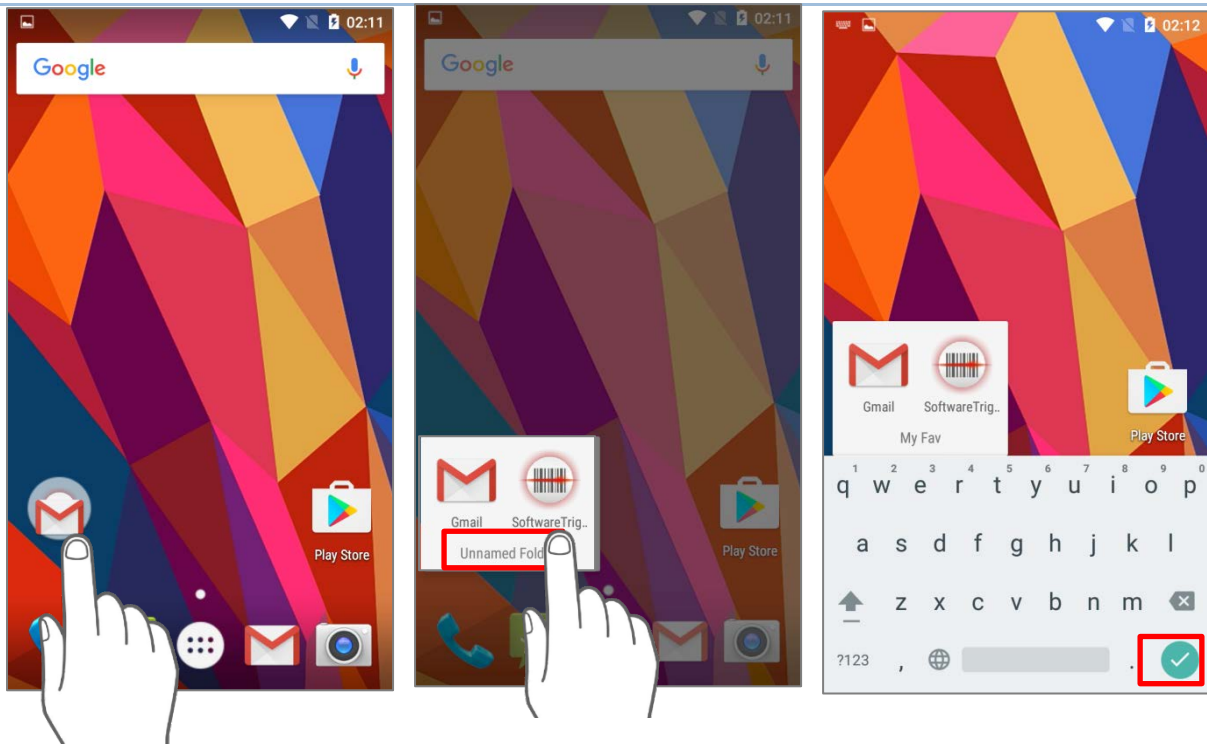

REMOVE FOLDER

- 1) Tap and hold the folder you would like to remove.
- 2) Drag the folder to the top of the screen where the option **"X Remove"** is located.

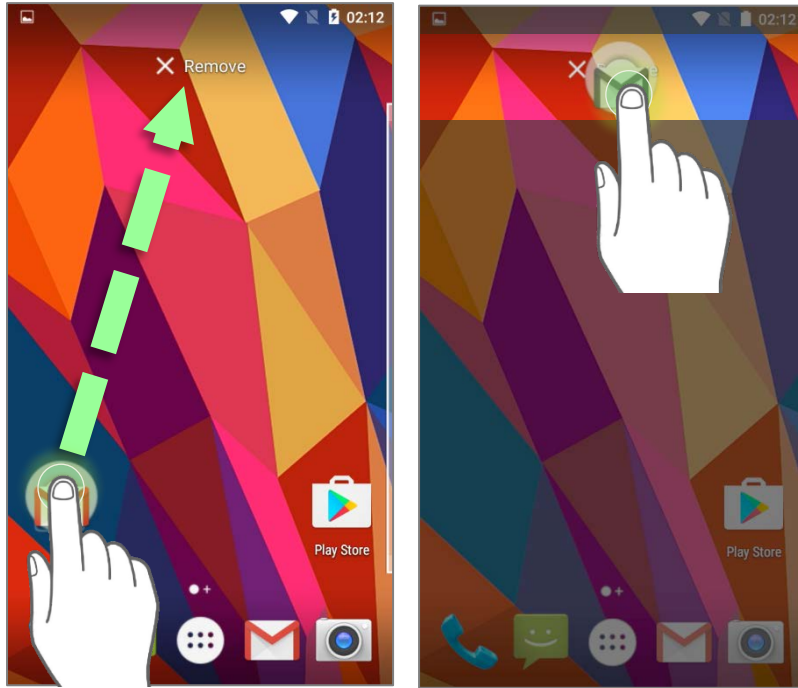

Note:

Please note that, when you remove a folder, the shortcuts contained in it will be removed as well.





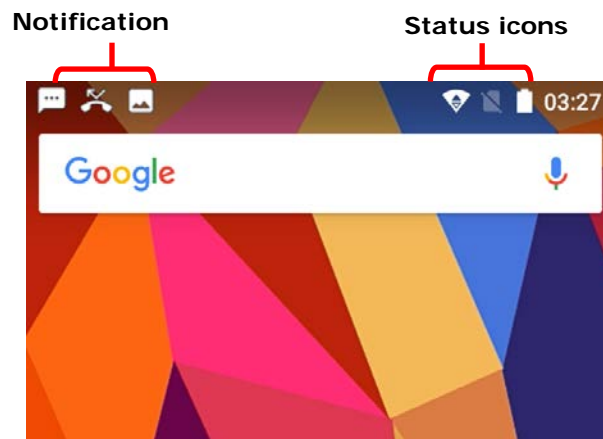





3.2. STATUS BAR

The left side of the status bar shows **notification icons**, and the right side of the status bar shows **status icons**.



3.2.1. ICONS ON STATUS BAR

STATUS ICONS

Icon	Description
	Bluetooth is on.
	The device has been connected to a Bluetooth device.
	The device is currently connected to a Wi-Fi network and performing data transmission.
	No mobile network signal
	The device is currently connected to a 4G network. A symbol will be shown on the left to indicate the cellular data connection type (e.g. 3G).
	Full mobile network signal
	Airplane mode is active, which means all radios are inactive now.
	Alarm is active.
	No SIM card is inserted
	All sounds are silent except for alarms (Vibration mode).



The main battery is fully charged.



The main battery is partially drained.



Main battery level is very low and needs charging immediately (<5%).



External power source is connected and main battery is being charged.

NOTIFICATION ICONS

Icon	Description
	USB debugging mode is enabled on this device
	The device is performing data synchronization.
	There is an upcoming event.
	The device is downloading data.
	The device is uploading data.
	An open Wi-Fi network is available.
	A memory card has been inserted.
	A new SIM card is detected.
	There has been a problem. Open Notifications Drawer for more details. For example: No SIM card detected in either of the two SIM card slots
	The headset has been inserted.
	The phone call is connected.
	There has (have) been missed call(s).
	The current phone call has been paused.
	Wi-Fi hotspot is active.
	Bluetooth tethering is active.
	USB tethering is active.

3.2.2. OPEN QUICK SETTING MENU

The **status icons** are related to essential settings regarding the device's remaining power, Bluetooth status or Wi-Fi connectivity status. The status bar offers a quick access for you to easily make adjustments of the settings. To open **Quick Setting** menu, use your two fingers to swipe from the top to the bottom of the screen. You can tap on each status icon on the menu to switch among different modes or enter the settings.

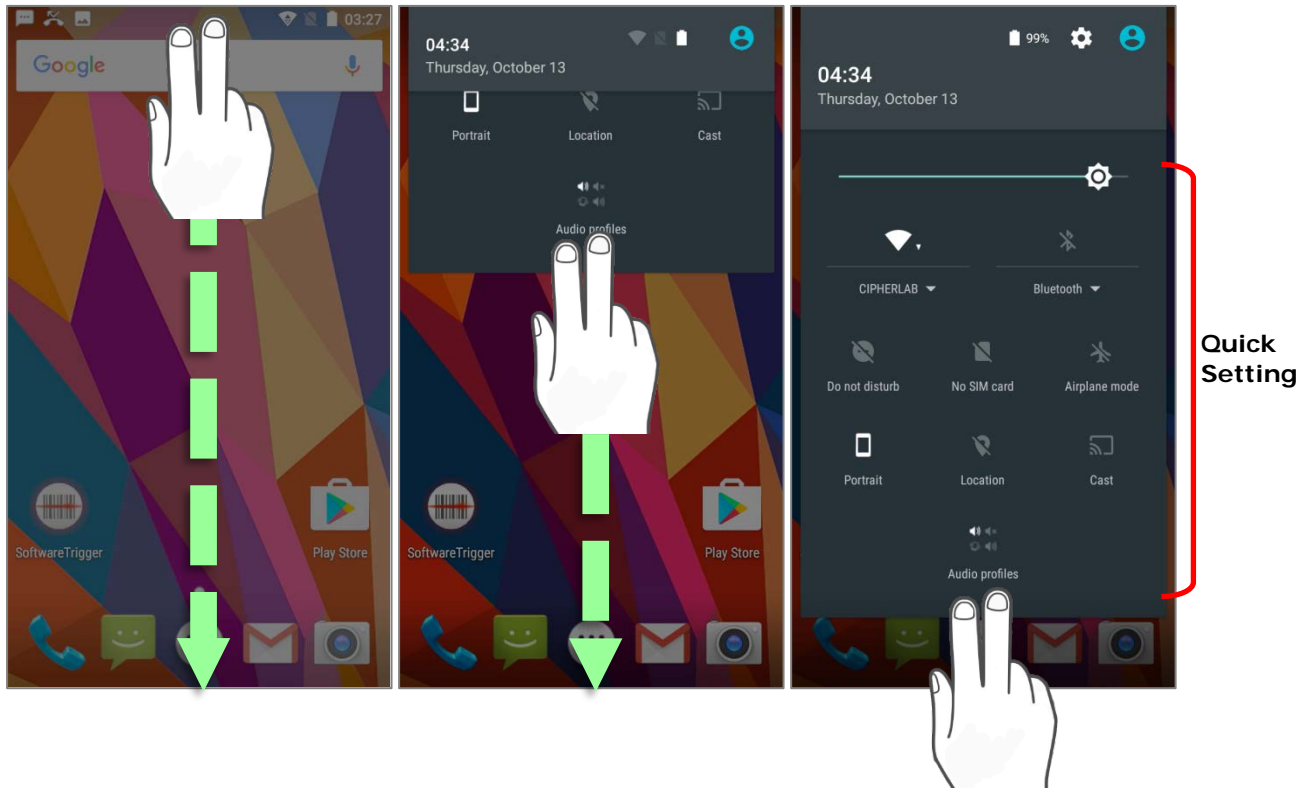

3.2.3. OPEN NOTIFICATIONS DRAWER

The **notifications icons** on status bar inform you of the new events such as incoming calls, messages or USB connection.

CHECK OUT NOTIFICATION

To check out details of the events, swipe down from the status bar to open [Notifications Drawer](#). Tap on the individual notification card to carry out immediate action or to open the corresponding application.

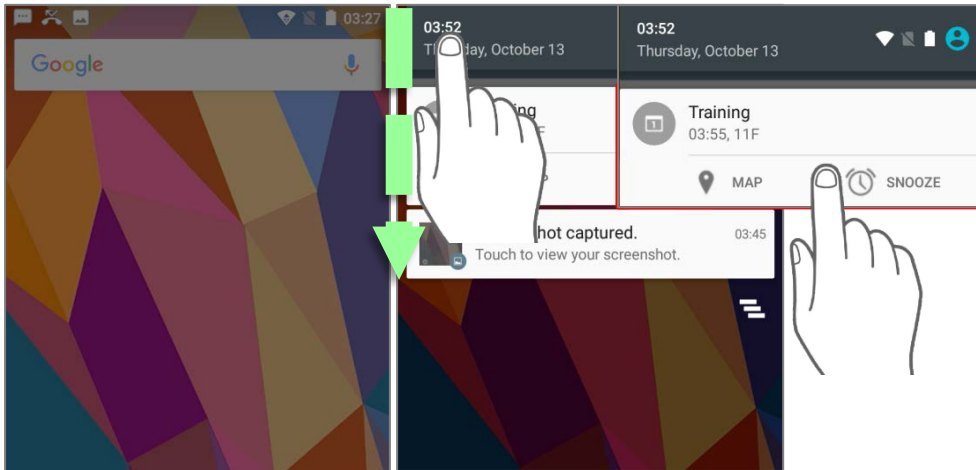

DISABLE NOTIFICATION

You can change or turn off the notification of a specific app by tapping and holding on the notifications card until the corresponding app name reveals along with an **i** icon, tap on it to modify the notification-related setting.

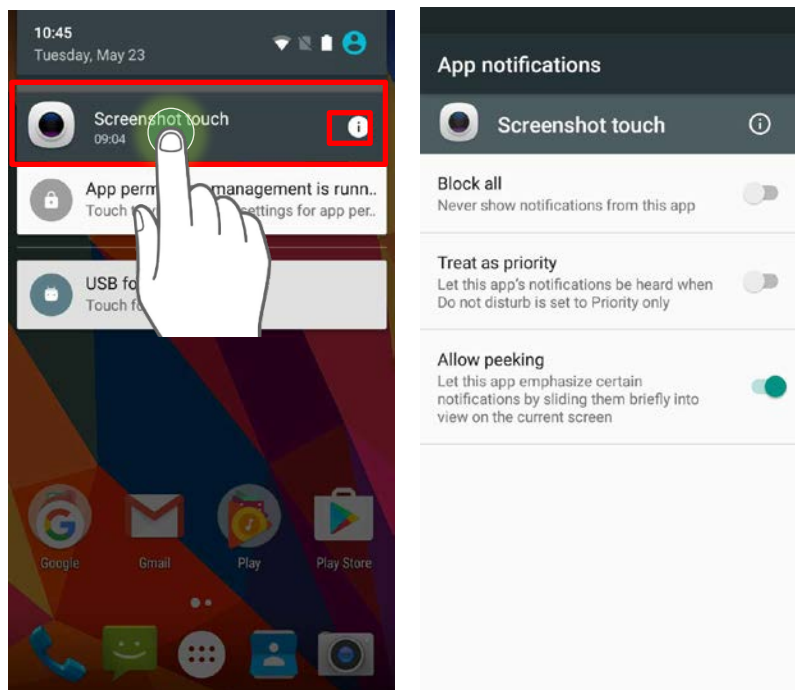

CLEAR NOTIFICATION



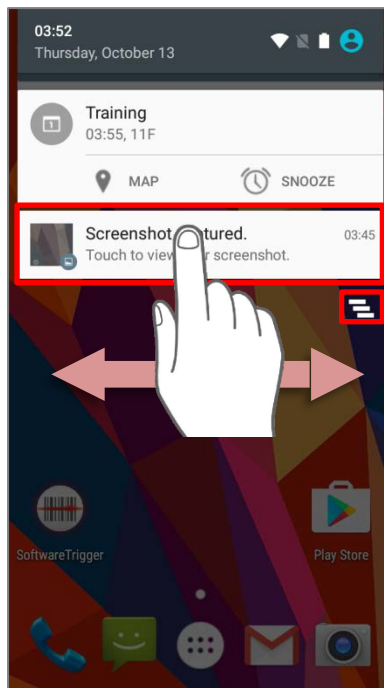











To dismiss a single notification, simply swipe the notification card right or left. You can also dismiss all notifications at a time by tapping . Ongoing notifications and notifications that require subsequent activity to be cleared will remain on the list.















3.3. MANAGE APPLICATIONS

3.3.1. APPLICATION MENU

Tap **All Apps**  on the **Home** screen to open the applications menu.

Icon	Name	Description
	AppLock	An application used to limit the system resources made available to Users
	Calculator	Performs mathematical calculations.
	Calendar	Creates and manages events, meetings and appointments.
	Camera	Takes pictures and shoots videos.
	Chrome	An Android built-in browser application developed by Google.
	Clock	Sets date, time, time zone according to your locale, and sets and manages alarms.
	Contacts	Manages contact information, and shares or exports/imports the information to other devices or SD card.
	Downloads	List all files downloaded on the mobile computer.
	Drive	An Android built-in application for a file storage and synchronization service created by Google.
	Duo	A one-to-one video call application developed by Google.
	File Manager	Browses and manages files on the local storage and storage card.
	Gmail	An Android built-in application for Gmail, a free email service provided by Google.
	Google	An Android built-in application providing you easy access to handy services provided by Google such as searching for nearby restaurants or updates on traffic alerts.
	Hangout	An Android built-in application for a communication platform developed by Google.
	Maps	An Android built-in app developed by Google.

	Messaging	Sends SMS and MMS messages.
	Phone	Places and receives calls, accesses voicemail, views call history, manages phone contacts and adjusts phone settings.
	Photos	An Android built-in application for a photo and video sharing and storage service developed by Google.
	Play Movies & TV	An Android built-in application for an online video on demand service operated by Google.
	Play Music	An Android built-in application for a music streaming service and online music locker operated by Google.
	Play Store	An Android built-in application providing access to a digital distribution service, including a digital media store, the Google Play Store , operated and developed by Google.
	Reader Config	Sets scanner preferences, data output format and destination, symbology settings, and reads barcodes.
	Search	Searches the internet and mobile computer with the search engine.
	Settings	Opens settings to configure the mobile computer.
	SoftwareTrigger	An application serving as a real trigger key, floating on top of all other programs for convenient trigger control of the barcode scanner.
	Sound Recorder	Records and plays audio information.
	Voice Search	An Android built-in Google product allowing users to use Google Search by speaking on a mobile phone.
	YouTube	An Android built-in application for a video-sharing service.

3.3.2. CURRENT APPLICATIONS

Tap the **Recent Apps** button . The screen will show a list of recently used applications.



On this screen, you can:

SWITCH BETWEEN APPLICATIONS

Swipe up or down to cycle through the listed applications; tap on your desired one to open it on the screen.

END APPLICATION

Slide an application to the left or right, or tap the **X** on top right to close it.

Note:

Close unused applications to release RAM space. Remember to save your data or settings before closing any application.

3.4. SUSPEND & LOCK

3.4.1. SUSPEND DEVICE

The mobile computer operates continuously once it is powered on. To minimize power consumption and prevent unintended operation, suspend the mobile computer if you are not actively using it. The mobile computer can be quickly awoken from suspend mode to operate as needed. When the mobile computer enters suspend mode, the system is in a power-saving status, meaning the device will not respond to screen touch, and volume keys and side buttons will also be unavailable until the device is unlocked.

SUSPEND RS50

Press the power button to immediately suspend the mobile computer. The mobile computer will also automatically get into suspend when the time interval set in [Screen Timeout Settings](#) has passed without any activity.

3.4.2. LOCK DEVICE

Setting a screen lock allows you to protect your personal data on this device while the device is not at your hand. With various types of screen lock available and Smart Lock, you can not only enjoy the benefits of this function but also great convenience.

LOCK RS31

Tap **All Apps** | **Settings** | **Security** | **Screen lock** to change the lock method.

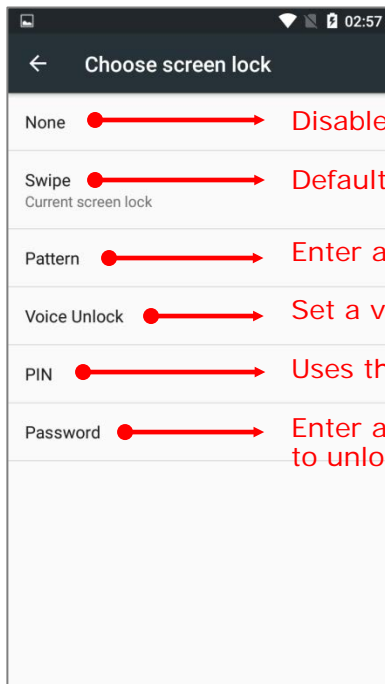
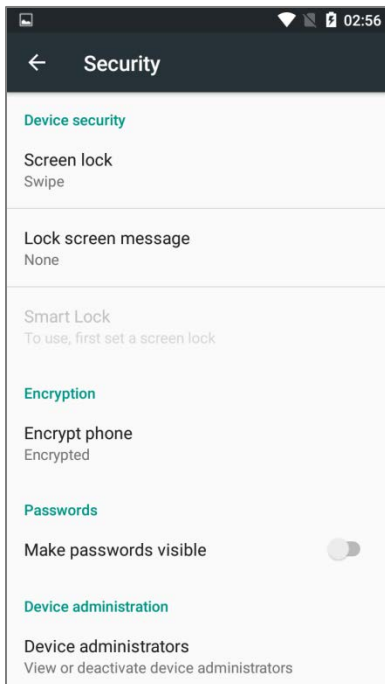

By selecting a pattern, Voice Unlock, Pin or Password method, you can access advanced settings and **Smart Lock** to customize personal lock settings.

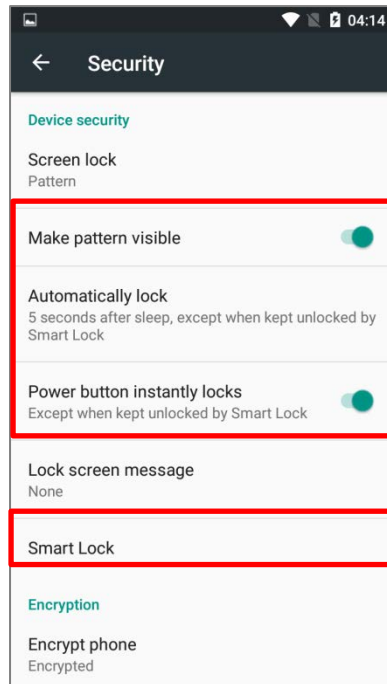

Warning:

To save battery power, suspend the mobile computer when not in use.

3.5. OS UPDATE

Updating the operating system on the mobile computer helps maintain it at an optimized state. You may choose to update the system by establishing a wireless network connection to the Internet and downloading the update file from the OTA server.

Note:

The mobile computer will shut down during system update. Save any unfinished tasks and data before updating the system in order to avoid data loss.

NETWORK UPDATE

In order to check for and download the latest system update file on the server, make sure a wireless network connection to the Internet is established on the mobile computer.

Note:

To avoid any additional charges to your wireless data plan, the Wi-Fi connection to the Internet is recommended for downloading the file.

- 1) Tap **All Apps** | **Settings** | **About phone** | **System updates**. A dialog pops up asking you to input the password for system update. Please contact with support@cipherlab.com.tw for the password. Enter the password and tap **OK**.

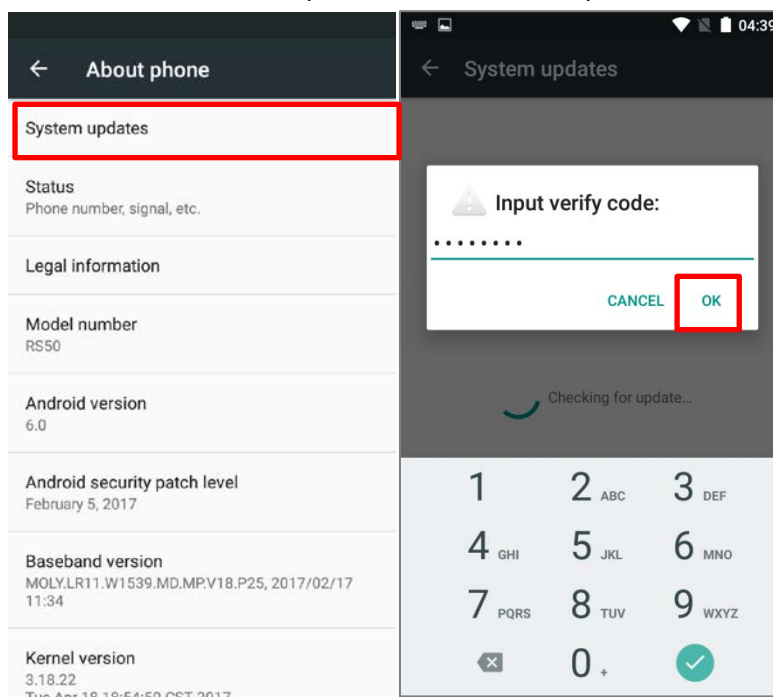

- 2) The mobile computer searches for the latest system update file on the server. Tap **DOWNLOAD AND INSTALL** to download the update file.
- 3) When a new system update file is detected on the server, a notification icon will appear on the status bar, and a text notification will pop up in the notifications panel.

SD CARD UPDATE

OS Update searches for available update files in your mobile computer's storage.

- 1) Obtain the latest system update image file, and copy the file onto the root storage of your SD card. Insert the SD card into the memory card slot on the device. Press the power button to power it on.

OR

Transfer the update image file to the root directory of the device's internal storage via USB cable.

Tap **All Apps**  | **Settings**  | **About phone**  | **System updates**.

- 2) A window pops up asking you to input the password for system update. Please contact with support@cipherlab.com.tw for the password. Enter the password and tap OK.

- 3) The mobile computer searches for an available system update file on the SD card.

Note:

Make sure the SD card is inserted in the mobile computer. If not, the screen will show that your system is currently up to date.



- 4) Tap **INSTALL** to open an "Install update" confirmation dialog. Tap **Install** in the confirmation dialog to begin the installation.

Once complete, a notification will appear showing that the system has been updated successfully. Tap **OK** to show the Home screen.



3.6. BACK UP YOUR DATA

With **Android Backup Service**, you can have your personal data (Google calendar settings, Google contacts, Chrome browser data and Gmail settings) and certain system settings under your Google account backed up (over network connection) on the cloud. This allows you to easily restore the settings on this device after a Factory Reset (refer to [Reset to Factory Default](#)).

Note:

- (1) To back up your photos and videos, Tap **All Apps**  | **Photos**  to sync the files on your device with Google Photo Library.
- (2) To back up other data such as audio or video files on the device's storage, you can make use of the Google Drive service.
- (3) **Android Backup Service** does not handle SMS messages and certain app progress data and settings.

To start:

- 1) Make sure your device is connected with network.
- 2) Tap **All Apps**  | **Backup & reset**  and enable **Back up my data**.
- 3) Tap **Backup Account** to log in to your Google account.

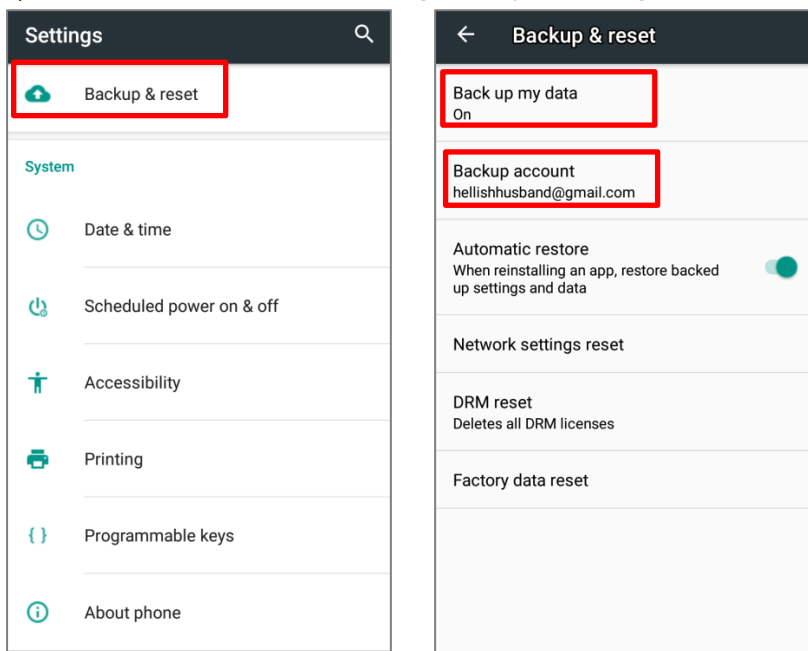

To restore your backed up personal data of a Google Account, just add that account to the device.

3.7. RESET TO FACTORY DEFAULT

Performing a factory reset will erase all data on your mobile computer (including call logs, messages, files as well as your installed apps and their associated data) and revert the device back to its original state in which it is powered on by you for the first time.

It is strongly recommended that you follow the instructions in [Back up Your Data](#) to back up important data before performing a factory reset.

To start:

- 1) Tap All Apps  | Settings  | Backup & reset  and Factory data reset.

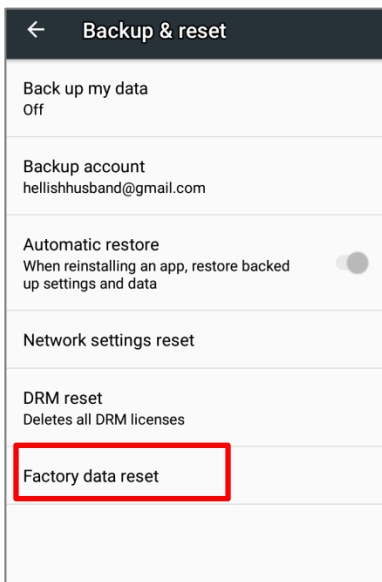

- 2) Confirm the action by tapping on the buttons and input the verification code (Please contact with support@cipherlab.com.tw to obtain your verification code). Finally, tap **OK** to perform a factory reset.

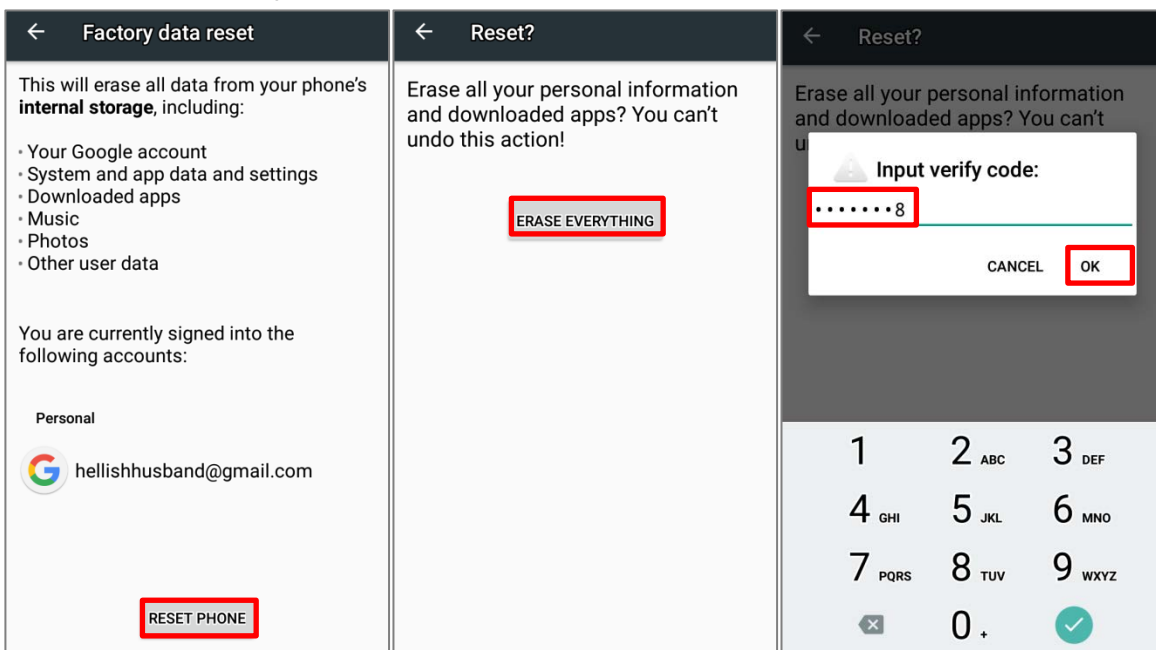

- 3) As the mobile computer boots up for the first time after the reset, the Welcome wizard will run you through setting up the environment as well as restoring apps and data. During setup, you can tap **SKIP** to continue to the next step (you can finish the respective settings in **All Apps** | **Settings** at any time). Please note, that to have the backed up data in your Google accounts restored right in this stage, log in to a Wi-Fi network when prompted to **Select Wi-Fi Network**.

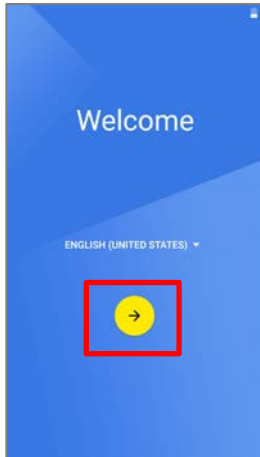

1. Tap the arrow to proceed.

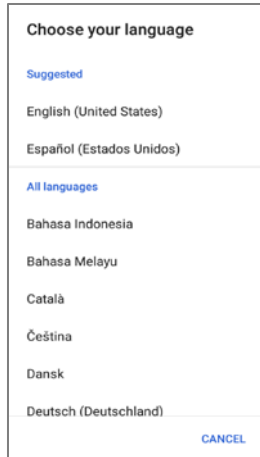

2. Select your system language.



3. Log in to your Wi-Fi network. If logged in, you will be further asked to sign in your Google account to restore data.

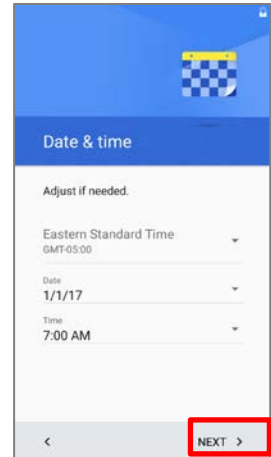

4. Set date & time.

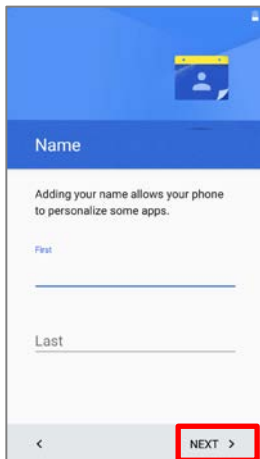

5. Input your name.

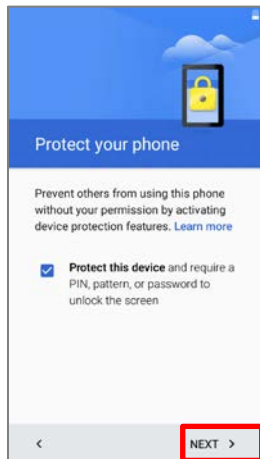

6. Set up the protection methods to protect this device.

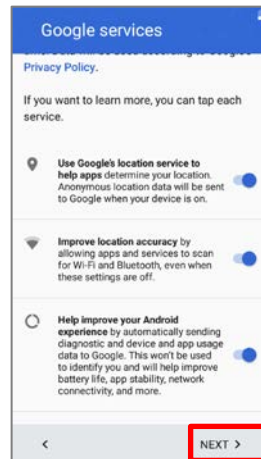

7. Choose Google services that you want to be enabled.

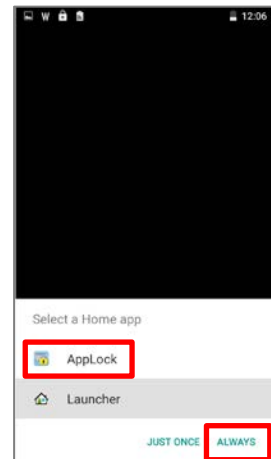

8. Choose whether to have AppLock take control of your Homescreen.

- 4) Once the initial setup is completed, tap **GOT IT** to start using your mobile computer. Apps and settings will be restored in the background.

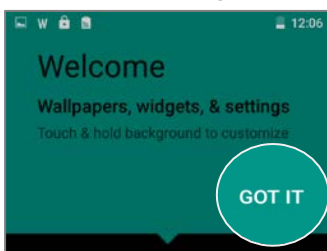

Chapter 4

WIRELESS RADIOS

With the Wi-Fi module integrated on the mobile computer, you can configure and connect to network wirelessly.

IN THIS CHAPTER

4.1 Use Wireless Wide Area Network.....	104
4.2 Use Wireless Local Area Network (Wi-Fi)	113
4.3 Use Bluetooth.....	118
4.4 Use Near Field Communications	122

4.1. USE WIRELESS WIDE AREA NETWORK

The mobile computer will be automatically configured to connect to your wireless service provider's network when you insert a SIM card and turn on data connection for the first time.

- 1) When a SIM card is inserted, a dialog will appear confirming the mobile carrier detected, you may tap **"Touch to set up"** to enter the settings page.

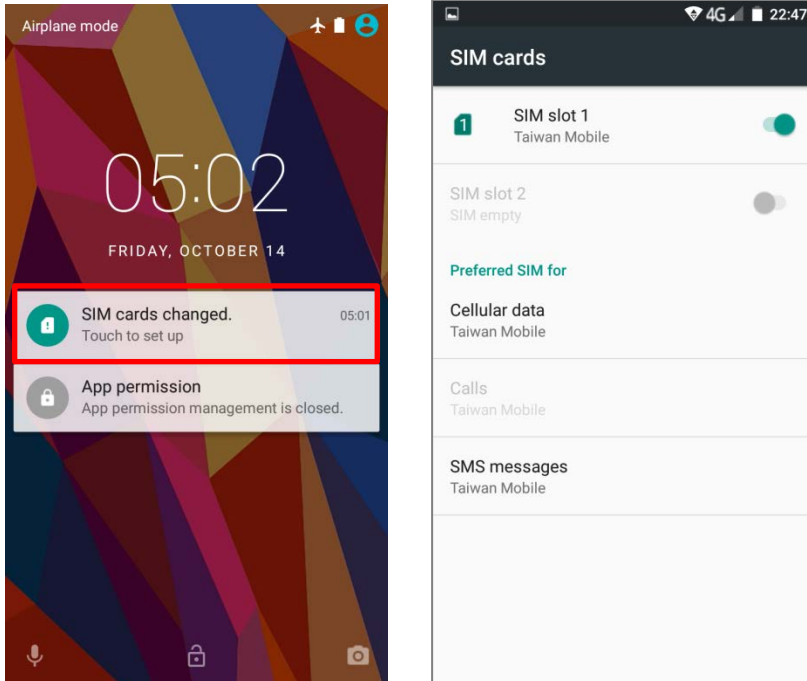



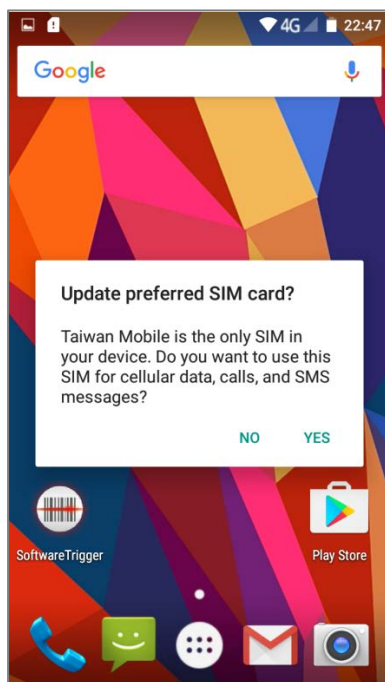

- 2) If the SIM card you inserted is the only SIM in your device, you will be prompted to confirm that this SIM used for all data services.



EDIT ACCESS POINT NAME

You may need to change the access point name according to the information obtained from your mobile carrier.

- 1) Tap **All Apps**  | **Settings**  | **More**  | **Cellular networks** | **Access Point Names**.
- 2) Tap the button , and tap each field to input the **APN** name and settings obtained from your mobile carrier.
- 3) When finished, tap the settings button  and tap **Save**.
- 4) Back to **APNs** page; tap the radio button next to the APN you would like to apply.

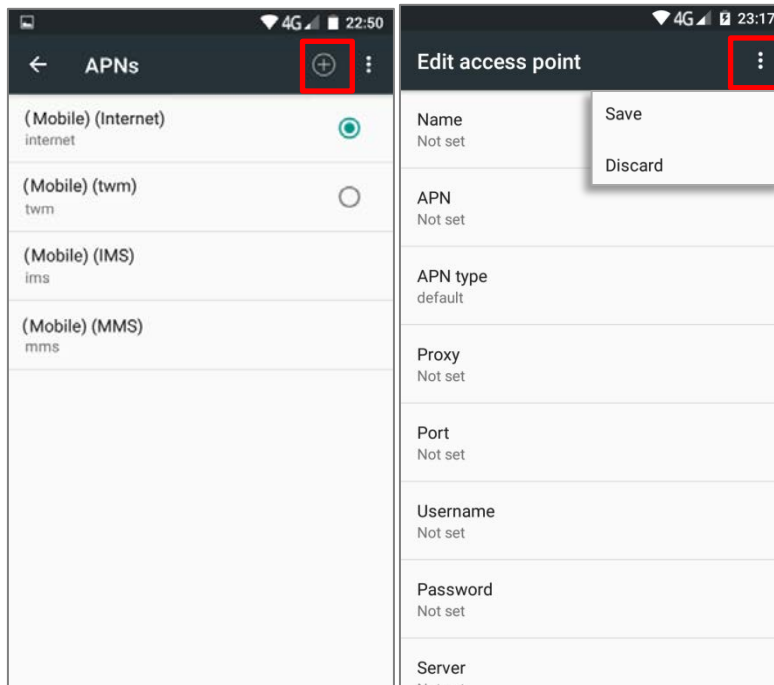





4.1.1. SHARE WWAN DATA

The WWAN connection on the mobile computer can be shared to other devices. You may share internet connection with a computer or device through USB or Bluetooth tethering, or share with a maximum of eight devices by turning the mobile computer into a Wi-Fi hotspot.

BLUETOOTH TETHERING

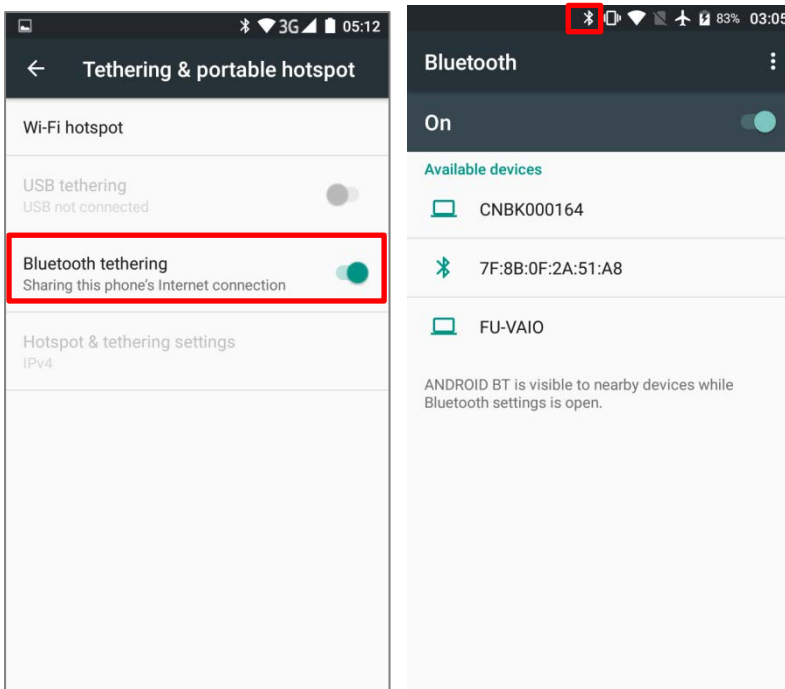

To share data connection through Bluetooth tethering:

- 1) Pair the mobile computer with the device of interest.
- 2) Tap **All Apps**  | **Settings**  | **More**  | **Tethering & portable hotspot**.
- 3) Tap **Bluetooth tethering**. The mobile computer will share its WWAN network with Bluetooth-connected devices through Bluetooth sharing. Once the sharing is successful, the icon  will appear on the top of the screen.



USB TETHERING

To share data connection through USB tethering:

- 1) Connect the mobile computer with a USB cable. A USB icon will appear at the top of the screen, and in the [Notifications Drawer](#), a description “**Connected as USB Storage**” will appear.
- 2) Tap **All Apps**  | **Settings**  | **More**  | **Tethering & portable hotspot**.
- 3) Tap **USB tethering**. The mobile computer will share its WWAN network with the connected host computer.

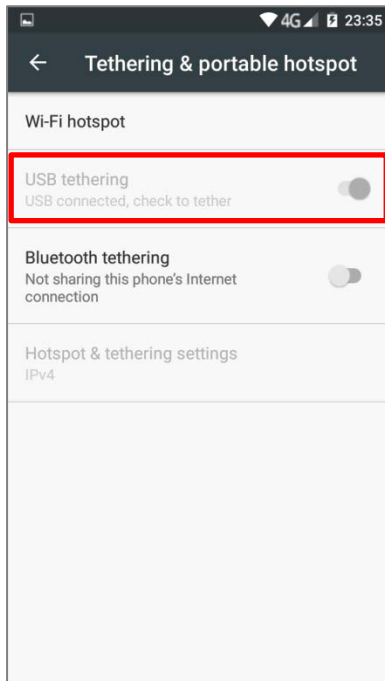

WI-FI HOTSPOT

To share data connection in the form of a Wi-Fi hotspot:

- 1) Tap **All Apps** | **Settings** | **More** | **Tethering & portable hotspot**.
- 2) Tap the **Wi-Fi hotspot** switch to enable data sharing through Wi-Fi. The mobile computer will start broadcasting its SSID for other devices to connect.

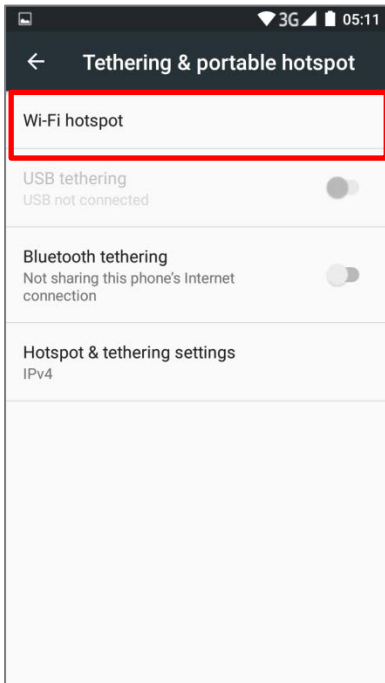

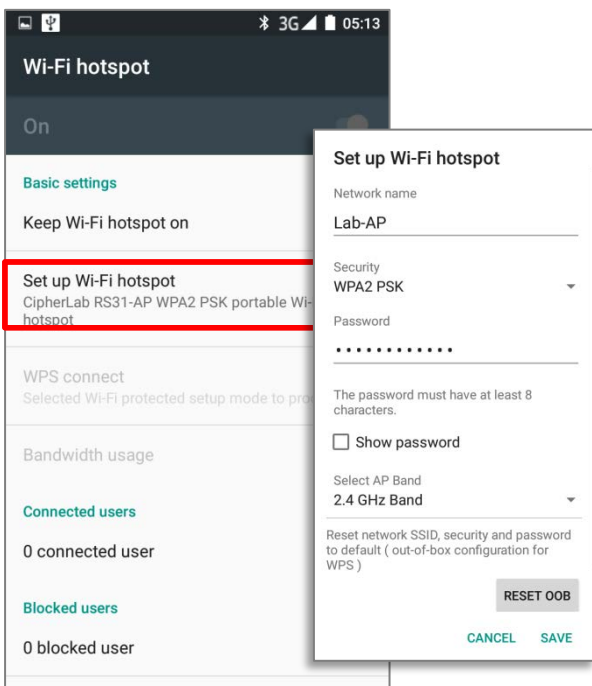

- 3) Tap the **Wi-Fi hotspot** label to manage Wi-Fi hotspot settings: set when to turn the Wi-Fi hotspot off, change SSID and security settings, select whether to minimize battery usage when Wi-Fi hotspot is enabled, enable WPS mode and adjust bandwidth, and view connected users.



DATA USAGE

Data usage is the amount of data uploaded or downloaded on the mobile computer. Managing the data usage amount within a certain period of time is a recommended task, as an excess amount of data usage might incur additional fees from your service provider.

To check wireless data usage:

- 1) Tap **All Apps**  | **Settings**  | **Data usage** .
- 2) The **Overview** tab page opens showing a summary of data usage for your mobile network and Wi-Fi connection. Open the tab page of your mobile carrier to view a chart of data usage on a monthly cycle.

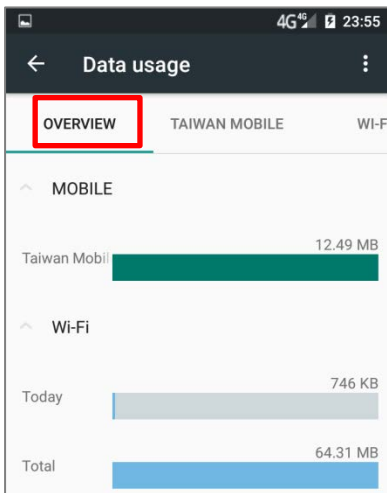

SET DATA USAGE LIMIT

- 1) On the data usage tab page for your mobile carrier. Enable **Set mobile data limit**.
- 2) To adjust the limit level, tap the limit value on the chart. If a limit is set, when the data usage amount reaches the limit, mobile data connection will be automatically disabled.

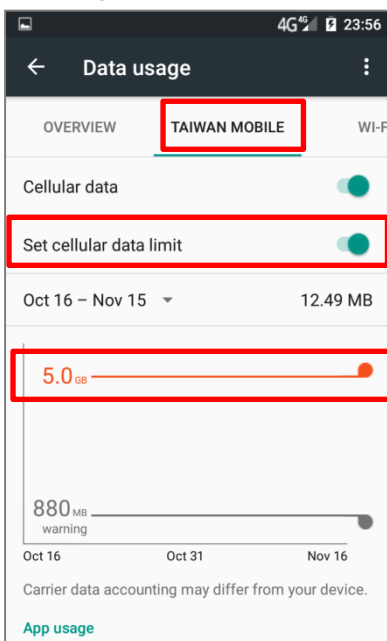

ENABLE DATA USAGE DURING ROAMING

- 1) On the data usage tab page for your mobile carrier, tap **More**.
- 2) Select **Cellular networks**, and enable **Data roaming** for your mobile carrier. A dialog box appears confirming whether you would like to enable data roaming. Tap **OK** to confirm.

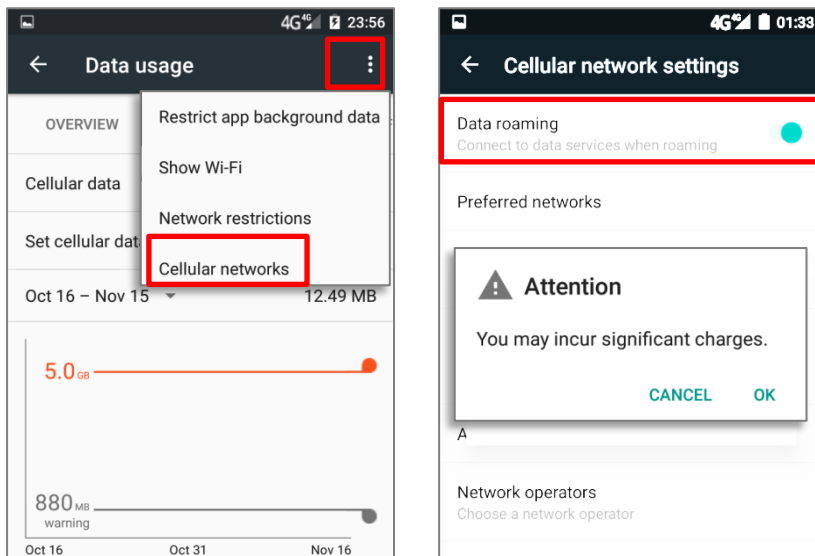

RESTRICT BACKGROUND DATA

- 1) On the data usage tab page for your mobile carrier, tap **More**, and select the **Restrict background data checkbox**.
- 2) A dialog box appears confirming whether you would like to enable data restriction. Tap **OK** to confirm.

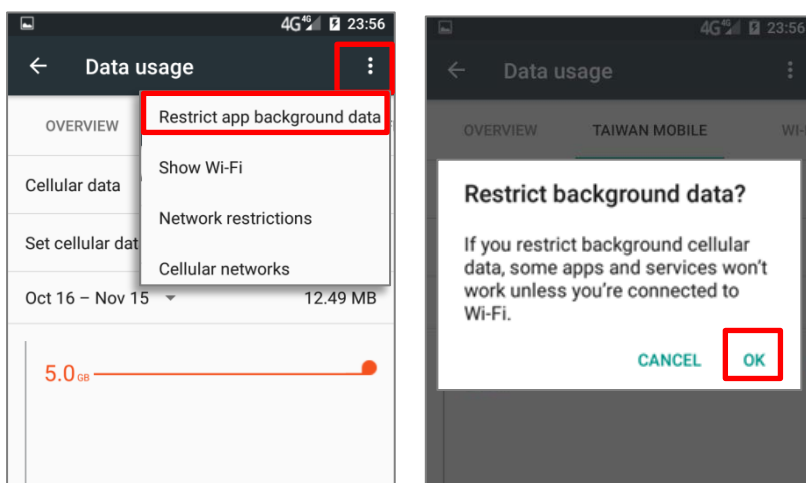

The mobile computer conserves data usage by restricting background mobile data. Certain applications and services will be disabled unless the mobile computer is connected to a Wi-Fi network.



4.1.2. DATA CONNECTION SETTINGS

TURN ON/OFF DATA CONNECTION

To manually turn on/off mobile data connection:

- 1) Tap **All Apps**  | **Settings**  | **Data usage** .
- 2) Select your data usage tab page for your mobile carrier. To turn on/off data connection, switch the **Cellular data** to the corresponding position.

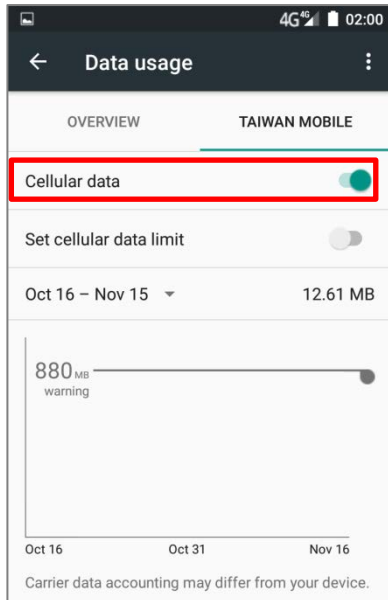

SELECT DATA CONNECTION TYPE

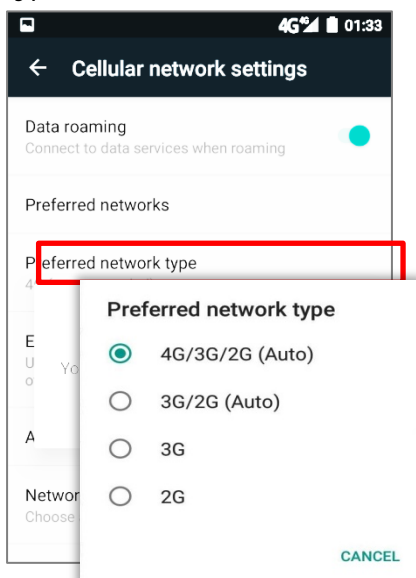

Tap **All Apps**  | **Settings**  | **More**  | **Cellular network**, tap Preferred network type to select.



4.1.3. SIM CARD SETTINGS

LOCK SIM CARD

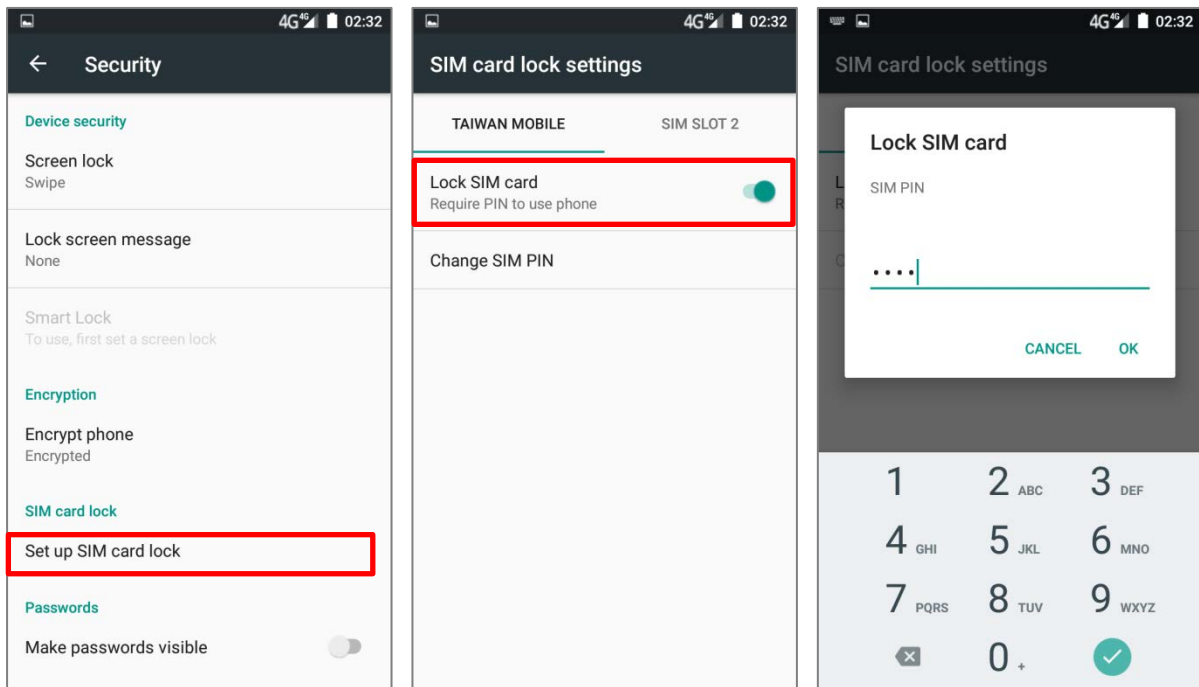

To lock the SIM card:

- 1) Tap **All Apps**  | **Settings**  | **Security**  , tap **Set up SIM card lock**.
- 2) Enable **Lock SIM card**.
- 3) Enter the PIN to enable SIM card lock. Once enabled, you are required to enter the PIN code in order to use the phone.



CHANGE PIN CODE

To change the PIN code:

- 1) Tap **All Apps**  | **Settings**  | **Security**  , tap **Set up SIM card lock**.
- 2) Tap **Change SIM PIN**.
- 3) Enter your old PIN code to confirm your identity, and then input a new PIN code.

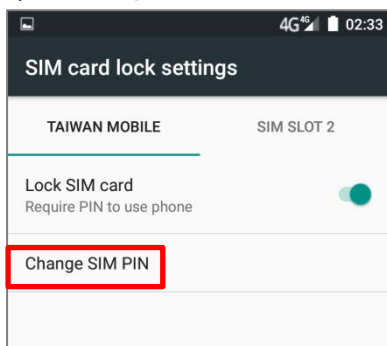

4.2. USE WIRELESS LOCAL AREA NETWORK (WI-FI)

4.2.1. CONNECT TO WI-FI NETWORK

To power on Wi-Fi:

- 1) Use two fingers to swipe down from the top of the screen to open **Quick Settings**.
- 2) Tap **Wi-Fi** ▼ to scan for available networks. Select a network to connect.

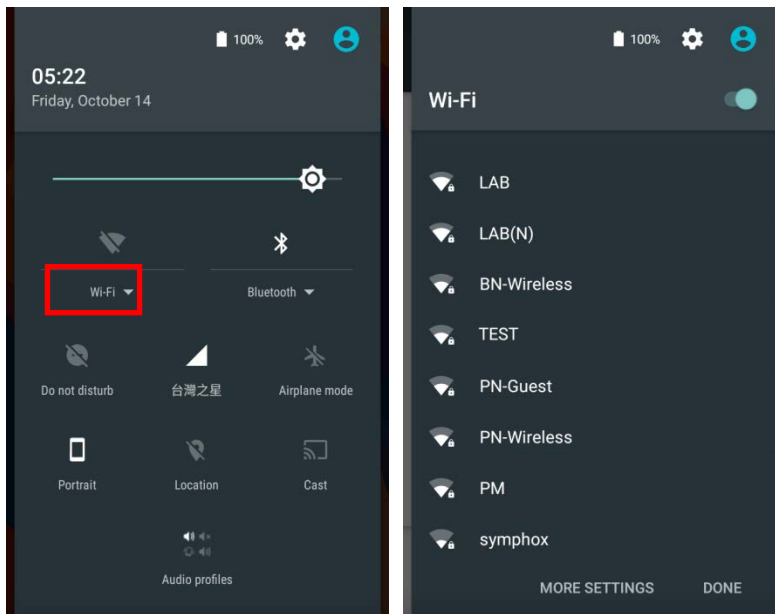



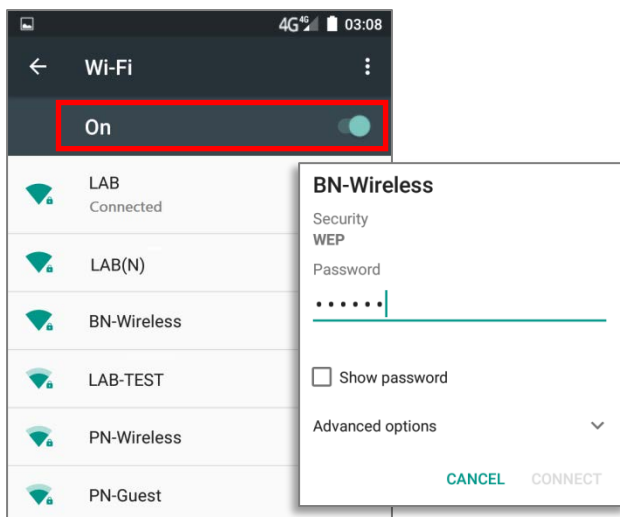

OR

- 1) Tap **All Apps** (⋮) | **Settings** (⚙️) | **Wi-Fi** (📶).
- 2) Tap the Wi-Fi switch to scan for available networks. Select a network to connect. If the network is an open one, the mobile computer will attempt to connect to it directly. When connected, the status will change to show **“Connected”**. If the network is a secured one, the mobile computer prompts a dialog to enter the password for the connection.



4.2.2. MANUALLY ADD WI-FI NETWORK

If the network you would like to connect to does not broadcast its SSID, or if the network is out of range, you may add it manually.

- 1) Tap **All Apps**  | **Settings**  | **Wi-Fi** .
- 2) Tap the Wi-Fi switch to enable this function, and then tap **More**  and select “**Add network**”.
- 3) In the dialog box, enter the name of the network in the **Network name** field, and select a security method in the **Security** field (None, WEP, WPA/WPA2 PSK, 802.1x EAP).
 - ▶ For WEP/WPA/WPA2 PSK connections: Enter the required password and tap **Save**.
 - ▶ For 802.1x EAP connections: Tap **Advanced options** and select the **EAP method** in the drop-down box (PEAP, TLS, TTLS, PWD, SIM, AKA), and the **Phase 2 authentication** in the drop-down box (None, MSCHAPV2, GTC). Select a **CA certificate** and **User certificate** if required (certificates may be installed under

All Apps  | **Settings**  | **Security** | **Install from SD card**

or **All Apps**  | **Settings**  | **Wi-Fi**  | **More**  | **Advanced** | **Install certificates**.) Enter your username in the **Identity** box and the password in the **Password** box if required.

The mobile computer supports the following certificate file extensions:

File Extension Type	Standard Certificate	Key Stored
Description	DER-encoded X.509 certificates saved in .crt or .cer files.	X.509 certificates saved in PKCS#12 key store files with a .p12 or .pfx extension.
How to install	change the extension to .crt or .cer.	Change the extension to .p12 or .pfx.

- 4) If necessary, select the **Proxy** server and **IPv4** settings. By default, no proxy is set and IP settings are set to **DHCP**.

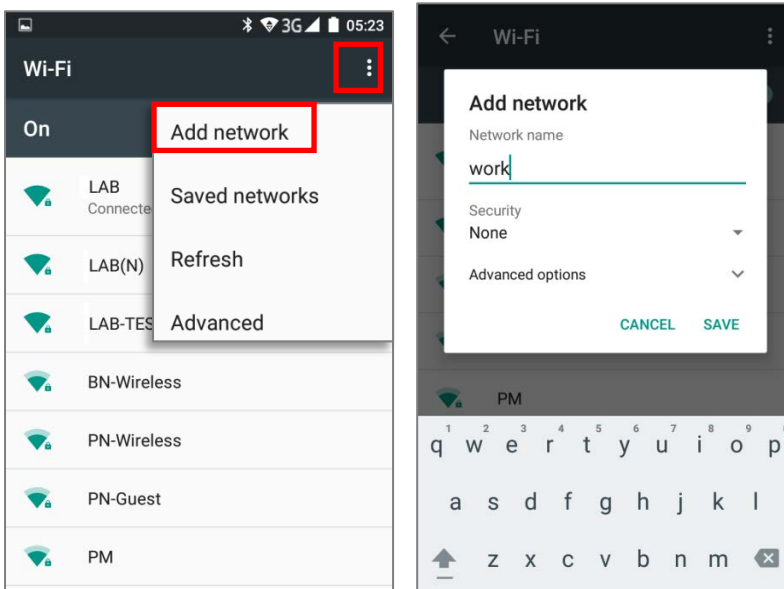

4.2.3. ADVANCED WI-FI SETTINGS

To configure advanced Wi-Fi settings:

- 1) On the **Wi-Fi** screen, tap **More**.
- 2) Select **Advanced** in the pop-up menu. Available settings are as below:

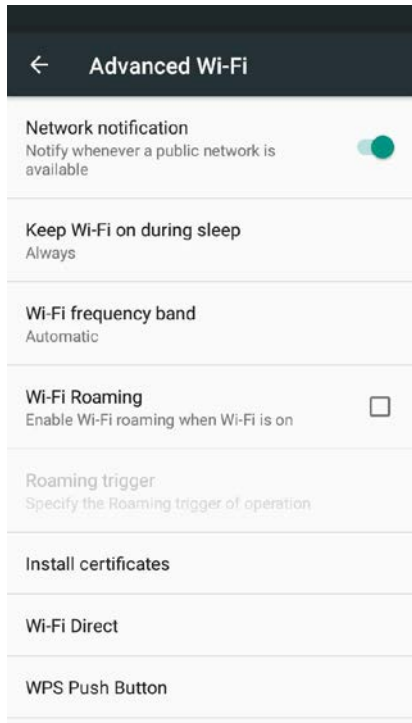

Item	Description
Network notification	Notifies when an open network is available.
Keep Wi-Fi on during sleep	Sets when to turn Wi-Fi on during sleep.
Wi-Fi frequency band	Two Wi-Fi frequency bands for stable network connection
Wi-Fi Roaming	Ensures connection when roaming in and outside without dropping a Wi-Fi signal
Install certificates	Installs certificates recently downloaded or placed on the internal storage.
Wi-Fi Direct	Enables your device to connect with a Wi-Fi Direct-capable device.
MAC address	Displays the MAC address of the device when connecting to Wi-Fi-networks.
WPS Push Button	Initialize the Wi-Fi protected setup (WPS) for a WPS-capable network. You will also have to press down the WPS button on your router.
WPS in Entry	Enter the personal identification number (PIN) for Wi-Fi protected setup (WPS) process.
IPv6 address	Displays the IPv6 address of the device.
IPv4 address	Displays the IPv4 address of the device.

4.2.4. CONFIGURE PROXY SERVER

A proxy server acts as an intermediary between an endpoint device and another server from which the device is requesting a service.

To change the proxy settings for a connection:

- 1) Tap a network in the available Wi-Fi hotspot list.
- 2) Tap **Advanced** options.
- 3) Tap **Proxy** and select **Manual** in the pop-up menu.
- 4) Enter the address of the proxy server in the **Proxy hostname** field. Enter the port number for the proxy server in the **Proxy port**. Enter the addresses of websites which are allowed to bypass the proxy server in the **Bypass proxy for** field. (Use the separator | between addresses.)
- 5) Tap **CONNECT**.

4.2.5. USE STATIC IP ADDRESS

By default, the device gets an IP address from DHCP when connecting to a wireless network. You may set for the device to connect to a network using a static IP address.

- 1) Tap a network in the available Wi-Fi hotspot list.
- 2) Tap **Advanced** options
- 3) Tap IPv4 **settings** and select **Static** in the pop-up menu.
- 4) Enter the IP address, gateway, network prefix length, DNS 1 address and DNS 2 address in the fields provided.
- 5) Tap **CONNECT**.

4.2.6. CONNECT WITH WI-FI PROTECTED SETUP (WPS)

Wi-Fi Protected Setup (WPS) allows easy establishment of a secure wireless network. The mobile computer supports WPS Push Button configuration.

- 1) On the Wi-Fi hotspot scanning screen, tap **More** , select **Advanced** and then **WPS Push Button**.
- 2) A dialog will pop-up on the screen showing the remaining time allowed for pressing the WPS button on the router.

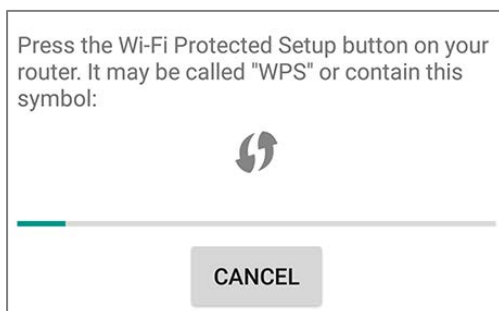

- 3) On your wireless router, press the WPS button. The device will connect to your router.

4.2.7. MODIFY WI-FI NETWORK

To change the settings for a connected network:

- 1) Tap and hold a connected network in the Wi-Fi hotspot list.
- 2) Tap **Modify network** in the pop-up menu.
- 3) In the dialog box that opens, modify the network settings, and tap **Save**.

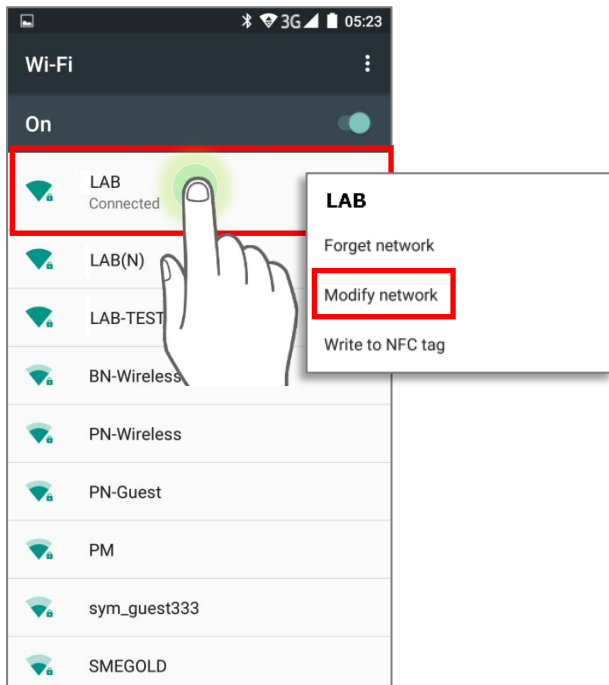

4.2.8. DISCONNECT WI-FI NETWORK

To disconnect a connected network:

- 1) Tap and hold a connected network in the Wi-Fi hotspot list.
- 2) Tap **Forget network** in the pop-up menu.

4.3. USE BLUETOOTH

You can configure Bluetooth settings and manage Bluetooth services provided on remote devices.

4.3.1. BLUETOOTH PROFILES

Bluetooth Profiles Supported

Generic Access Profile	(GAP)	For device discovery and authentication.
Service Discovery Access Profile	(SDAP)	Discovers services on remote devices.
Headset Profile	(HSP)	Describes how a Bluetooth enabled headset should communicate with a Bluetooth enabled device
Serial Port Profile	(SPP)	Sets up a virtual serial port to connect two Bluetooth devices.
Human Interface Device Profile	(HID)	Provides a low latency Bluetooth connection with keyboards, pointing devices, etc.
Object Push Profile	(OPP)	Pushes and pulls objects to and from a push server.
Hands-Free Profile (AG1.5)	(HFP)	Allows using a hands-free device to place and receive calls.
Advanced Audio Distribution Profile	(A2DP)	Streams stereo-quality audio to a wireless headset or speaker.
Audio/Video Remote Control Profile	(AVRCP)	Allows controlling of television and Hi-Fi equipment.
Generic Object Exchange Profile	(GOEP)	Provides a basis for other data profiles.
Personal Area Networking Profile	(PAN)	Uses Bluetooth Network Encapsulation Protocol for Bluetooth transmission.
General Audio/Video Distribution Profile	(GAVDP)	Provides a basis for A2DP and VDP.
Phone Book Access Profile	(PBAP)	Transfers Phone Book Objects to a car kit to display the information of an incoming call received on the mobile computer, or initiate a call.

4.3.2. TURN ON BLUETOOTH

By default, Bluetooth is turned off, to turn it on:

- 1) Use two fingers to swipe down from the top of the screen to open **Quick Settings**.
- 2) Tap **Bluetooth** ▼ to turn on this function while enabling the Bluetooth visibility of this device.

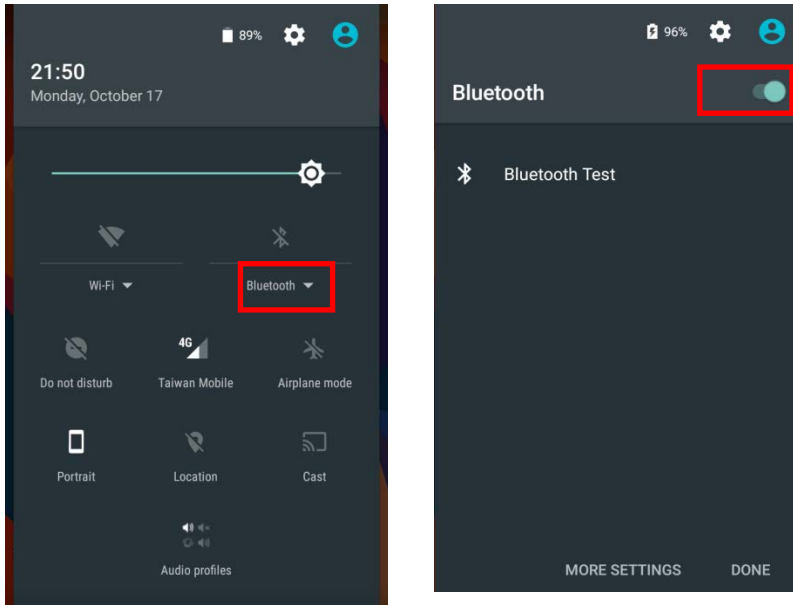

OR

- 1) Tap **All Apps** (⋮) | **Settings** (⚙️) | **Bluetooth** (📶).
- 2) Tap the switch to turn on this function while enabling the Bluetooth visibility of this device.

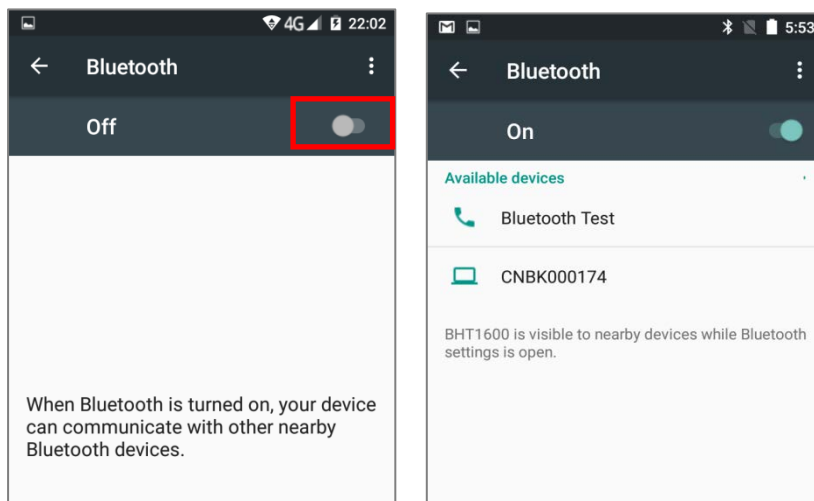

Note: After Bluetooth power is turned on, it is maintained even when the mobile computer is suspended. However, if the power mode is switched to Airplane Mode, Bluetooth power will be turned off regardless of the settings.



4.3.3. CHANGE BLUETOOTH NAME

To change the Bluetooth name of this mobile computer:

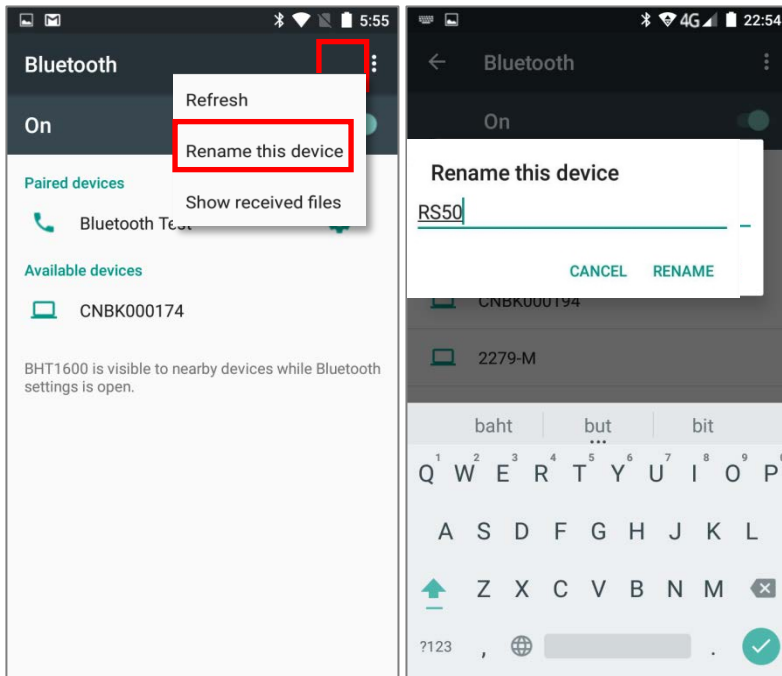
- 1) On the available Bluetooth devices screen, tap **More**  and select **Rename this device** in the pop-up menu.
- 2) Type a new name in the field and tap **RENAME**.



4.3.4. PAIR BLUETOOTH DEVICES

- 1) Tap **All Apps**  | **Settings**  | **Bluetooth** . Tap the switch to **On** to scan for available Bluetooth devices nearby. Scroll through the list and tap the device you would like to pair.
- 2) The **Bluetooth pairing request** dialog opens. Depending on the pairing settings of the Bluetooth device, you may need to enter a passkey, or confirm the assigned passkey on the device to pair if a smart pairing method is applied. Enter/confirm the passkey on the device to pair.
- 3) Once pairing is done, the Bluetooth device will be listed in the **Paired Devices** list.

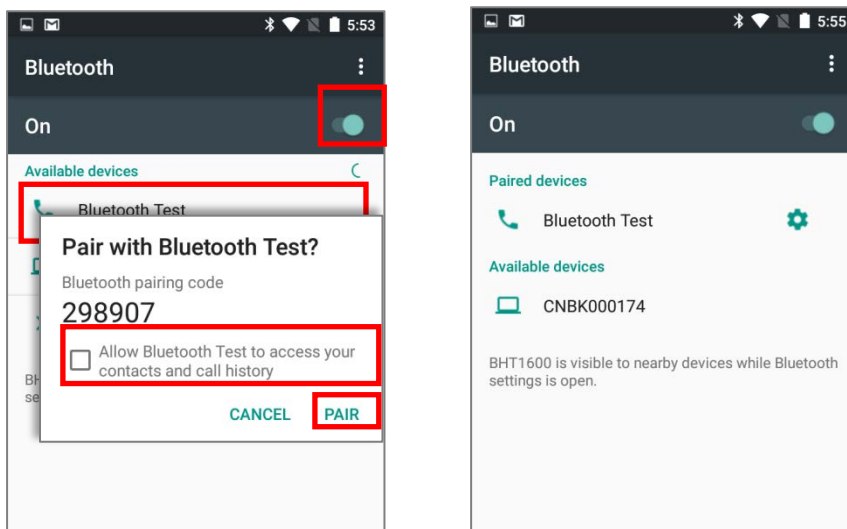

Note:

If the device you would like to pair with is not listed, make sure Bluetooth visibility is enabled on the device.

4.3.5. UNPAIR BLUETOOTH DEVICE

To unpair a paired device:

- 1) In the **Paired Devices** list, tap the settings button  next to the paired device.
- 2) On the **Paired device** dialog, tap **FORGET**.

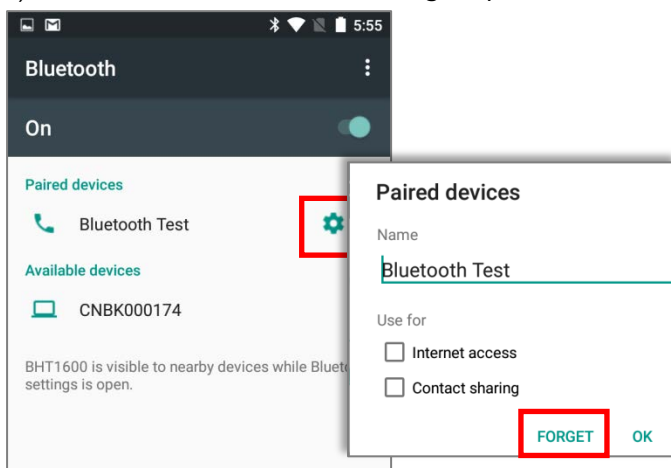

4.4. USE NEAR FIELD COMMUNICATIONS

Near field communications (NFC) uses close proximity (4 cm or less) to establish radio communication through electromagnetic fields. With NFC enabled, the mobile computer can collect information from NFC tags, exchange information with other NFC supported devices, and even change information on the NFC tag if authorized.

Before starting to communicate through NFC, perform the following:

- 1) On the mobile computer, tap **All Apps** | **Settings** | **More**.
- 2) On the Wireless & networks page, make sure the **NFC** switch is enabled.

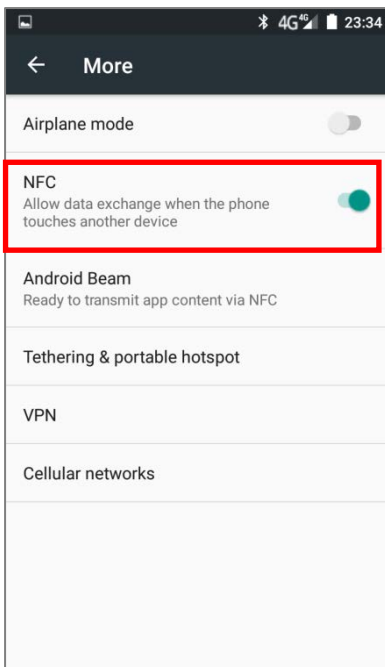

Tap **Android Beam** and enable it.

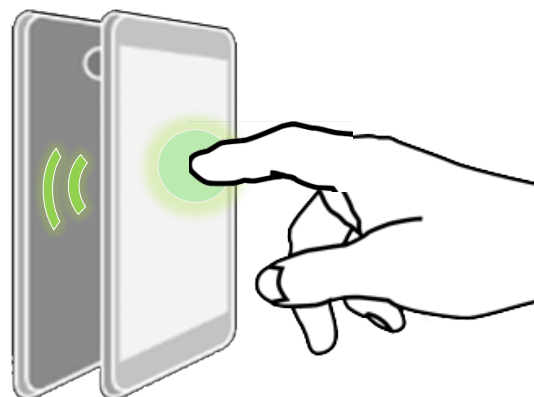
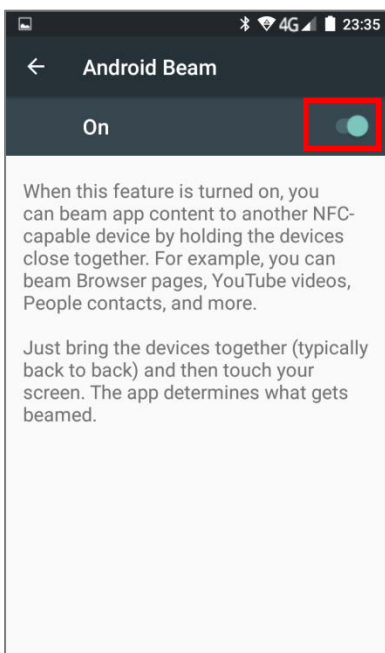

PAIR WITH NFC ENABLED BLUETOOTH DEVICES

- 1) On the device you would like to pair with, make sure NFC is enabled and Bluetooth discovery is enabled.
- 2) Hold the mobile computer without covering the antenna area at the lower end of the battery.

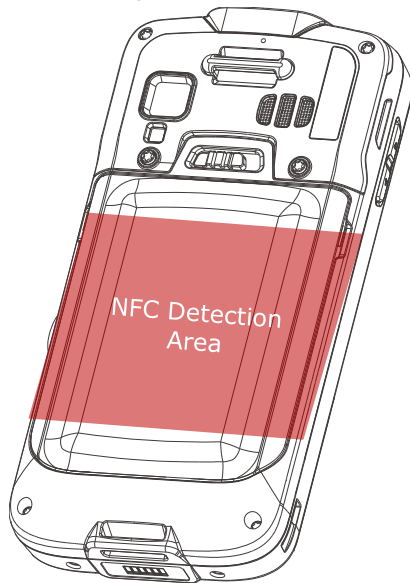

Move the mobile computer in proximity with the device. A screen notification will appear to indicate that pairing is successful.

SHARE INFORMATION

- 1) Open the web page, video, photo or contact info page you would like to transfer.
- 2) Place the back of the mobile computer in close proximity with the other device you would like to share data with.
- 3) When the two devices connect, a **"Touch to beam"** notification will appear on the screen.
- 4) Touch the screen to initiate data transfer.

Note:

Once the data begins to transfer, just keep the two devices in the distance within 10 m (32.8 ft.); they no longer have to be held within close range in order to transfer successfully.

COMMUNICATION WITH NFC

- 1) On the mobile computer, launch an NFC enabled application.
- 2) Hold the mobile computer without covering the antenna area at the lower end of the battery.
- 3) Place the mobile computer close to the NFC tag or device until the application indicates data transfer is complete.

USING THE PHONE

The RS50 mobile computer allows making phone calls and connecting to the network over Wideband Code Division Multiple Access (WCDMA). Insert the SIM card before turning on the power. Refer to [Installing SIM Card, SAM Card and Memory Card](#).

Note: If the SIM card is not in position, you may make emergency calls if the service is supported.

IN THIS CHAPTER



5.1 SIM Card Management	125
5.2 Phone Application	126
5.3 Audio Modes.....	134
5.4 In-call Volume	134

5.1. SIM CARD MANAGEMENT

The mobile computer accommodates two SIM cards and supports dual standby of two different networks. Both networks will be monitored at the same time, and the phone will dynamically switch between the two networks during usage. Calls will be placed with either one of the networks; you cannot switch networks in the middle of a received call or placed call, or receive or place calls with both networks at the same time.

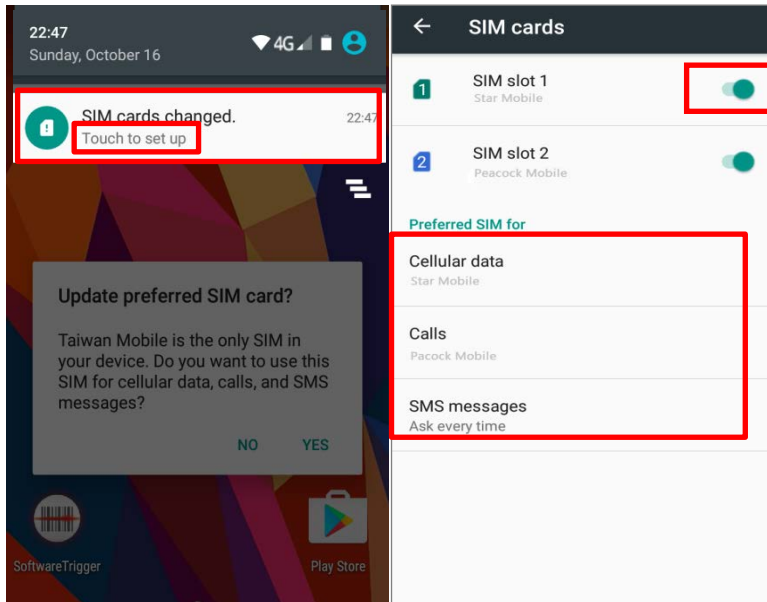
When a SIM card is installed for the first time, the phone power is turned on automatically when the mobile computer is powered on. A dialog box pops-up when the mobile computer is powered on notifying that a SIM card is detected.



- 1) Tap Touch to set up.
- 2) The **SIM cards** screen opens showing the name of the mobile carrier and the current phone settings.
- 3) To open the SIM card management screen from other screens, tap **All Apps**  | **Settings**  | **SIM cards** 
- 4) If you already have both **SIM1** and **SIM2** cards inserted, enable these cards on the **SIM cards** screen and respectively select the **Preferred SIM** for Cellular data, Calls and SMS messages.

Note:

When both SIM cards are inserted and enabled, they are active and ready to receive an incoming call but not able to be connected at the same time.

EMERGENCY CALLS





Depending on your service provider, the mobile computer might support making emergency phone call when the SIM card is locked, or even when no SIM card is inserted. Emergency phone numbers will vary by country.

5.2. PHONE APPLICATION

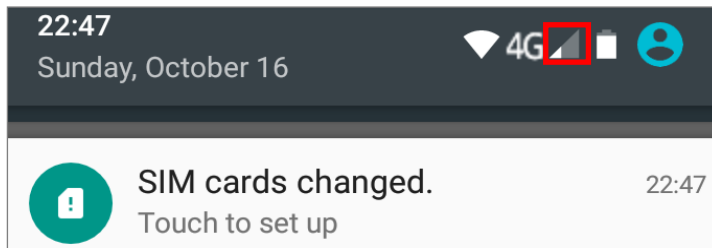
5.2.1. PHONE INTERFACE



- 1) When a SIM card is installed on the mobile computer, a signal icon appears on the status bar. The number of bars indicates the strength of the connection.

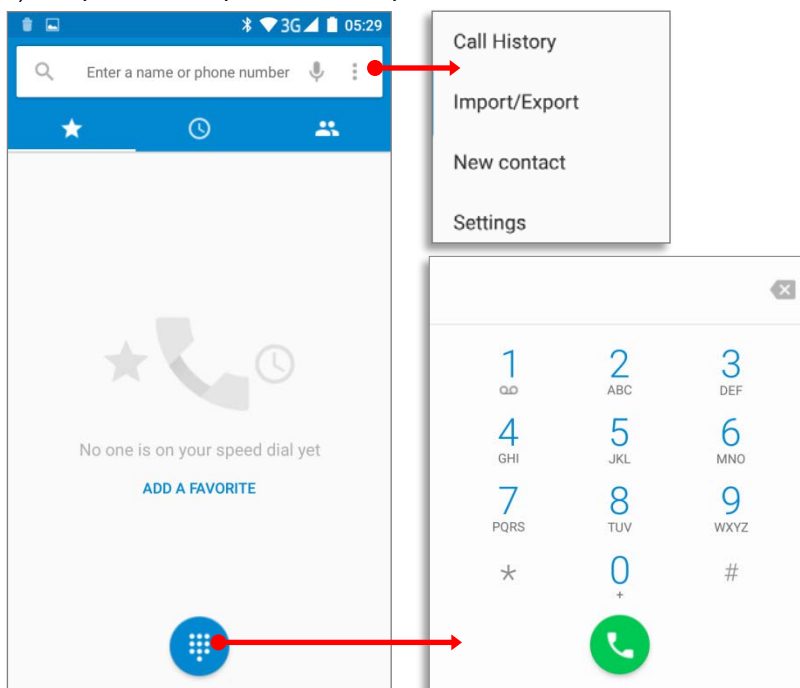

- 2) Tap **All Apps**  | **Phone** . The Phone application opens.
- 3) Tap the settings button  to open the phone settings menu for adding a new contact, opening the People application.
- 4) Tap  to open the dial pad.



5.2.2. PLACE CALL



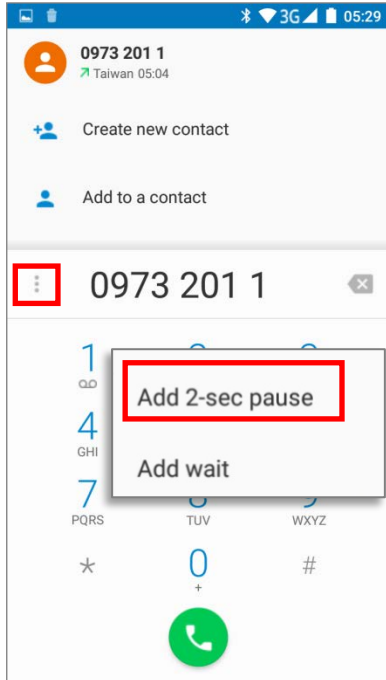

Enter the phone number in the dial pad and tap  to initiate the call. If you need to frequently make calls to an interactive voice system, you may tap  next to the number and select **Add 2-sec pause** for soft pause (a pause of 2 seconds to the buttons) or a hard pause (a pause that will wait for your confirmation to send the following digits).

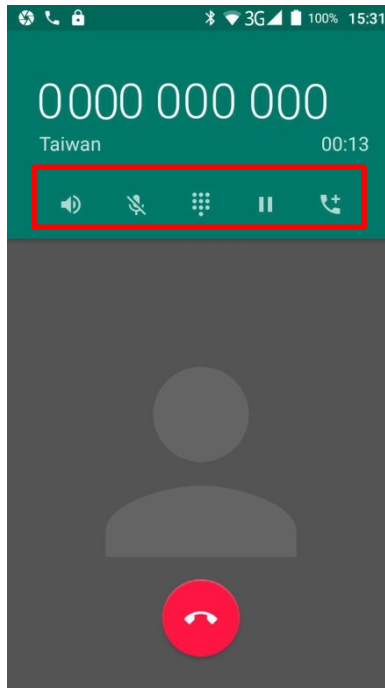

5.2.3. DURING A CALL

When a call is connected, the phone keypad features the following buttons:



Button	Description
	Opens the dial pad.
	Turns on the speaker.
	Mutes the call.
	Places the call on hold.
	Add call: Adds another person to the call.

PLACE CALL USING CONTACTS

To make a call using contacts:

- 1) In the phone application page, tap .
- 2) Tap a contact to initiate a call.

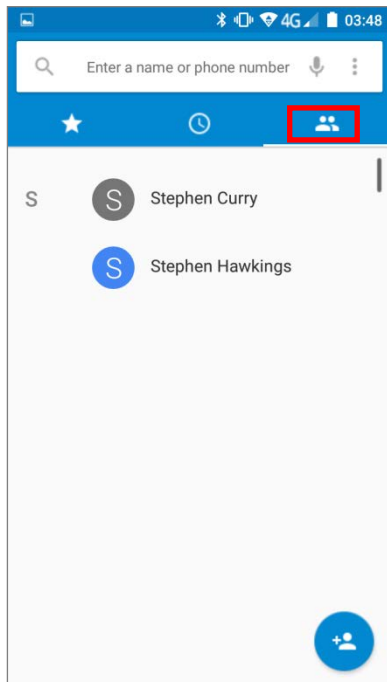

5.2.4. RECEIVE INCOMING CALL

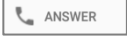
When a call is incoming on the mobile computer, tap  to pick it up.

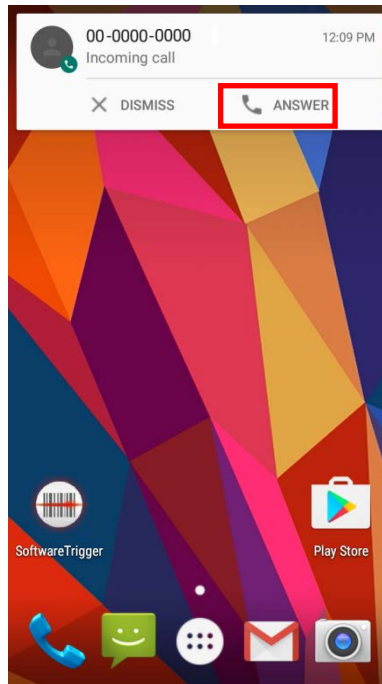

Incoming calls will be logged in the **Phone** application; in the case of a missed call, a notification will be displayed. See [Check Missed Calls](#).

To mute the ringtone of an incoming call, press the volume down button.

5.2.5. CHECK MISSED CALLS

If you have a missed call, a notification icon  will appear on the status bar. The number of missed calls will also be displayed next to **Phone** icon.

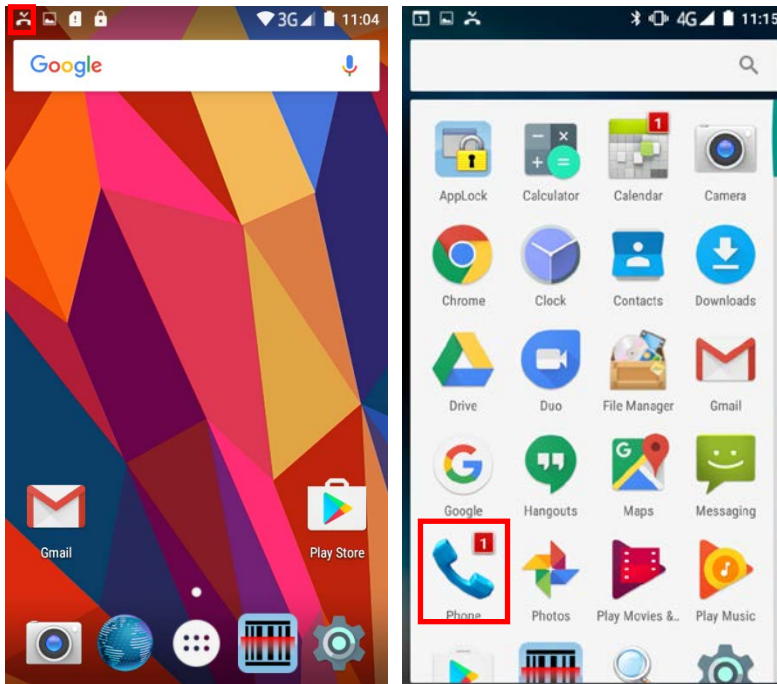



Unlock the screen and use the [Notifications Drawer](#) to manage the missed call.

5.2.6. CALL HISTORY

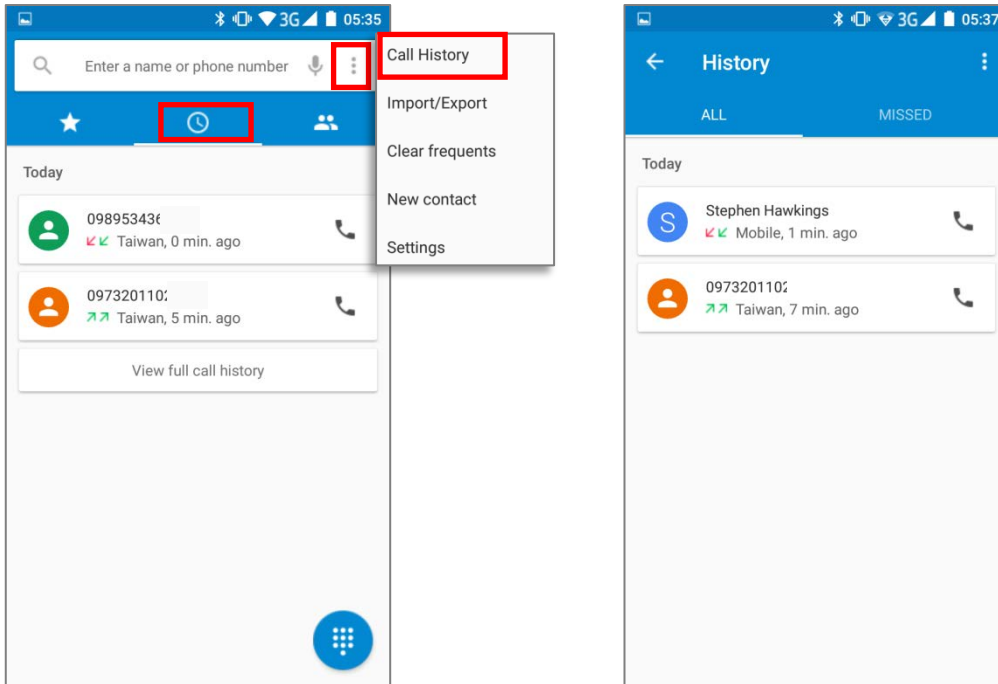
- 1) On the Phone application page, tap the **History** button  to open a list of history calls. Or you can tap the settings button  and then **Call History**.











Button	Description
	Connected calls.
	Missed calls.

- 2) Tap the phone icon  next to a call record to place back the call.

5.2.7. MAKE MULTI-PARTY CALLS

To make multi-party conference calls:

- 1) On the Phone application page, enter the first number to call and tap  to initiate the call.
- 2) After the call has begun, tap  and then **Add call** to add another member. The first call will be put on hold.
- 3) Enter the second number to call and tap  to initiate the call.
- 4) When the second call is connected, the first call will continue to be on hold. Tap the merge call button  to add the first call to the conversation. A three-party conference call is initiated.
 - ▶ To add a fourth member, tap . The three-party call will be put on hold. Enter another number to call and tap  to initiate the call. When the call is connected, the three-party call will continue to be on hold. Tap the merge call button  to add the three-party call to the conversation. A four-party conference call is then initiated.
 - ▶ Tap **Manage Conference** to view all members of the call.
 - ▶ To remove a member, tap  next to the member.
 - ▶ To speak with a member in private, tap the member, and the conference call will be put on hold. Tap  to return back to the conference call.

5.3. AUDIO MODES

The mobile computer offers three different audio modes for phone calls:

HANDSET MODE

This is the default audio mode which uses the receiver above the touchscreen for audio output during calls.

SPEAKER MODE

This mode uses the built-in speaker for audio output during calls.

HEADSET MODE

Connect a Bluetooth headset or a wired headset to the mobile computer for audio output during calls.

USE BLUETOOTH HEADSET

See [Pair Bluetooth Devices](#) to connect the mobile computer to a Bluetooth device. The speaker phone becomes muted when a Bluetooth headset is connected.

USE WIRED HEADSET

Insert a wired headset depicted in the [Overview](#). The speaker phone becomes muted when a wired headset is connected.

5.4. IN-CALL VOLUME

Use the volume buttons to adjust the ringer volume and system sound level. When in the middle of a call, use the volume buttons to adjust in-call conversation volume.

Chapter 6

USING READER CONFIGURATION UTILITY

The **Reader Configuration** utility allows you to manage the barcode reader integrated on the mobile computer.

IN THIS CHAPTER



6.1 Configuring Reader	136
6.2 Read Printed Barcodes	155

6.1. CONFIGURING READER

The mobile computer, equipped with either a (laser) 1D reader or a 2D imager scan engine, is capable of reading printed barcodes. The installed ReaderConfig utility on the mobile computer is to configure the scan engine; use the utility to create a profile of settings that best suits your needs.

LAUNCH READERCONFIG

To launch ReaderConfig:

- 1) Tap **Apps**  | **ReaderConfig**  to open the reader configuration utility.
- 2) **ReaderConfig** launches in context with the reader module(s) on board the mobile computer. On the main settings page are three sections: **General Settings**, **Symbology** and **Miscellaneous**.

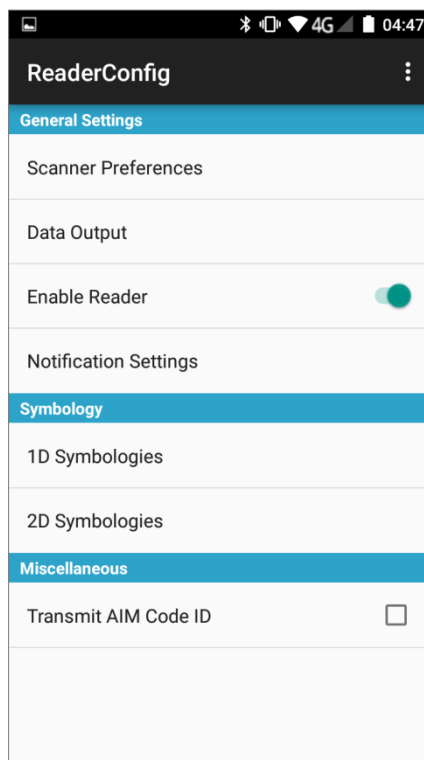

6.1.1. GENERAL SETTINGS

General Settings is where all reader settings are accessed from. Tap each item to enter its sub-menu.

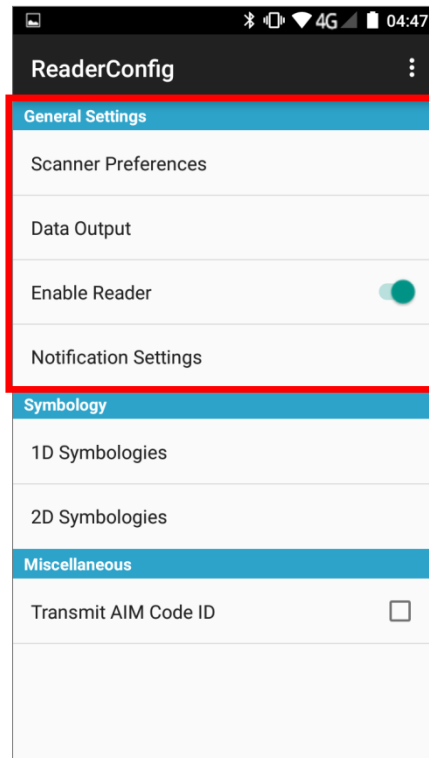

The functions under **General Settings** include:

- ▶ Scanner Preferences
- ▶ Data Output
- ▶ Enable Reader (enabled by default)
- ▶ Notification Settings

SCANNER PREFERENCES

Options on the **Scanner Preferences** page differ according to the type of scan engine built within the mobile computer.

To open **Scanner Preferences** page:

- 1) Open **ReaderConfig** as described in [Launch ReaderConfig](#).
- 2) Tap **Scanner Preferences**.

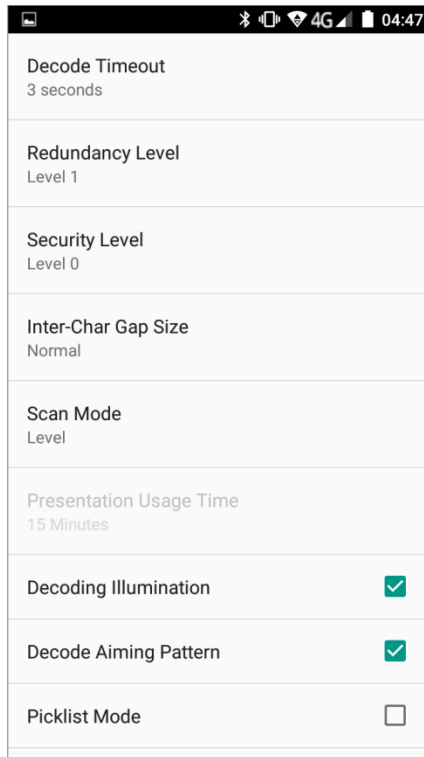

2D IMAGER SETTINGS

Setting	Description	Default										
Decode Timeout	Sets the maximum time for the decoding process during a scan. Configurable between 1 sec to 9 sec.	3 sec.										
Redundancy Level	Sets how many successful readings should be done before linear barcodes such as Codabar, MSI, and Interleaved 2 of 5 can be decoded. Levels 1 to 4 available.	Level 1										
Security Level	<p>Sets the security level to ensure decoding accuracy considering the printed quality of barcodes such as Code 128, Code 93, and UPC/EAN. The higher the level is, the more security is ensured. Options are:</p> <table border="1"> <thead> <tr> <th>Level</th> <th>Description</th> </tr> </thead> <tbody> <tr> <td>0</td> <td>With this default, the scan engine is aggressive enough to decode most "in-spec" barcodes.</td> </tr> <tr> <td>1</td> <td>Select this level if misdecodes have occurred. It fixes most misdecodes.</td> </tr> <tr> <td>2</td> <td>Select this level if Level 1 should fail to eliminate misdecodes.</td> </tr> <tr> <td>3</td> <td>Select this level if Security Level 2 should fail to prevent misdecodes. However, as this level actually impairs the decoding ability of the decoder, a safer solution would be to improve the quality of the bar codes to read.</td> </tr> </tbody> </table>	Level	Description	0	With this default, the scan engine is aggressive enough to decode most "in-spec" barcodes.	1	Select this level if misdecodes have occurred. It fixes most misdecodes.	2	Select this level if Level 1 should fail to eliminate misdecodes.	3	Select this level if Security Level 2 should fail to prevent misdecodes. However, as this level actually impairs the decoding ability of the decoder, a safer solution would be to improve the quality of the bar codes to read.	Level 0
Level	Description											
0	With this default, the scan engine is aggressive enough to decode most "in-spec" barcodes.											
1	Select this level if misdecodes have occurred. It fixes most misdecodes.											
2	Select this level if Level 1 should fail to eliminate misdecodes.											
3	Select this level if Security Level 2 should fail to prevent misdecodes. However, as this level actually impairs the decoding ability of the decoder, a safer solution would be to improve the quality of the bar codes to read.											
Inter-Char Gap Size	Sets the intercharacter gap size for Code 39 and Codabar. This option is to allow the digital scanner to adjust its decoding standard so as to tolerate out-of-specification bar codes that are improperly printed out (which may cause the intercharacter size to become larger). Switch between Normal and Large .	Normal										
Scan Mode	<p>Sets the reader's scanning behavior.</p> <p>Level: The decoding process is activated by a trigger event, and continues until the trigger event ends, a valid decode happens or decode session time-out is reached.</p> <p>Presentation Mode: When this device is executing Barcode reader service under this mode, the reader module will stay active and automatically turn off after the user-defined period of time (Presentation Usage Time).</p>	Level										
Presentation Usage Time	This option is available when Presentation is selected as the scan mode. This defines the duration of how long Presentation mode stays active, after which the laser light beam will automatically be disabled.	15 Minutes										
Decoding Illumination	Enables an LED light beam to aid barcode reading.	Selected (Enabled)										
Decode Aiming Pattern	Projects a crosshair at the center of the laser light beam to facilitate barcode reading.	Selected (Enabled)										
Picklist Mode	When selected, only barcodes aligned at the crosshair of the laser light beam will be decoded.	Deselected (Disabled)										
Display Mode	Enable improved performance for reading barcodes on electronic displays and mobile phones.	Deselected (Disabled)										

Inverse Type	Decide whether to disable or enable decoding inverse barcodes, or set as auto.	Regular only
Addon Redundancy	Functions when "auto-discriminate" is applied for UPC/EAN addons. Decides the number of times of supplemental decoding of the same barcode in order to count as a valid read. Configurable between 2 and 30.	10
Illumination Power Level	Users can adjust the illumination brightness of the LED light source. Move the slider to specify a value ranging from 1 to 10 to set the brightness level which is set to 10 by default meaning 100% illuminated.	10

DATA OUTPUT

Data Output allows users to set the way to output decoded data.

To open **Data Output** settings page:

- 1) Open **Reader Config** as described in [Launch ReaderConfig](#).
- 2) Tap **Data Output**.

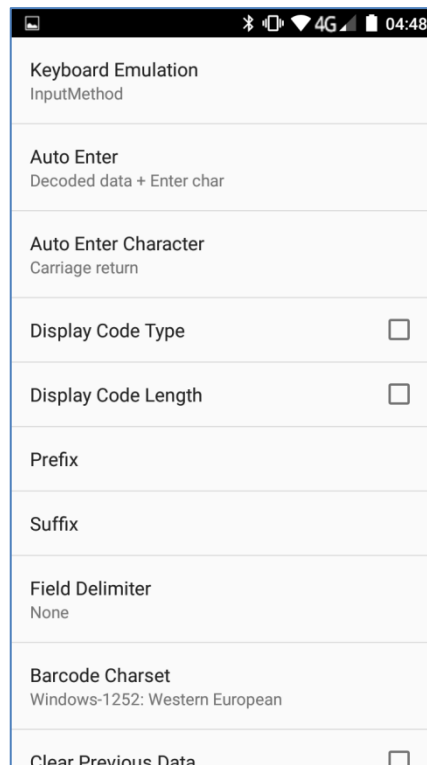

WHERE TO OUTPUT

Keyboard Emulation setting controls where the decoded data is to be output.

Setting	Descriptions	Default
Keyboard Emulation	Tap the switch to enable. When enabled, the reader module treats decoded data as typed text and outputs it to the active application on the mobile computer. Options are: <ul style="list-style-type: none">▶ None▶ InputMethod▶ KeyEvent	InputMethod

HOW TO OUTPUT

After the output destination is set, configure how to output decoded data, i.e. the "format" to present decoded data.

Setting	Description	Default
Auto Enter	Adds an ENTER character before or after each string of decoded data. The ENTER character can be defined in the "Auto Enter character" field below. This function saves the trouble of pressing a confirmation key to accept each string of decoded data. Options are: <ul style="list-style-type: none"> ▶ Disable ▶ Decoded data + Enter char ▶ Enter char + Decoded data 	Decoded data + Enter char
Auto Enter character	Adds a key code before or after the decoded data. If [Auto Enter] is enabled, select the ENTER character to send. Options are: <ul style="list-style-type: none"> ▶ None ▶ Carriage Return ▶ Tab ▶ Space ▶ Comma ▶ Semicolon 	Carriage Return
Display Code Type	Prefixes the output data with code type information.	Deselected (Disabled)
Display Code Length	Suffixes the output data with code length information.	Deselected (Disabled)
Prefix	Affixes 0 to 10 characters to the left of the output data. Tap the label to open a character table for entering the prefix. <ul style="list-style-type: none"> ▶ Prefixes containing invisible characters are supported. 	--
Suffix	Affixes 0 to 10 characters to the right of the output data. Tap the label to open a character table for entering the suffix. <ul style="list-style-type: none"> ▶ Suffixes containing invisible characters are supported. 	--
Field Delimiter	Sets the delimiter to separate the output barcode data to the following pieces: code type, decoded barcode data, and code length (if applicable). Options are: <ul style="list-style-type: none"> ▶ None ▶ Comma ▶ Semicolon ▶ Full stop 	None
Barcode charset	Specifies the current decoding for barcode data.	Windows-1252:Western European
Clear Previous Data	By enabling this option, only the last scanned data entry will be output.	Deselected (Disabled)

ENABLE READER

Features a switch to enable or disable reader scanning ability. When enabled, a light beam will be sent out from the scanning window each time the trigger (scan key) is pressed.

NOTIFICATION SETTINGS

Notification Settings enables audible, visible and tactile feedback for scanning good read, which helps notify the user of a successful decoding.

To open **Notification Settings** page:

- 1) Open **ReaderConfig** as described in [Launch ReaderConfig](#).
- 2) Tap **Notification Settings**.

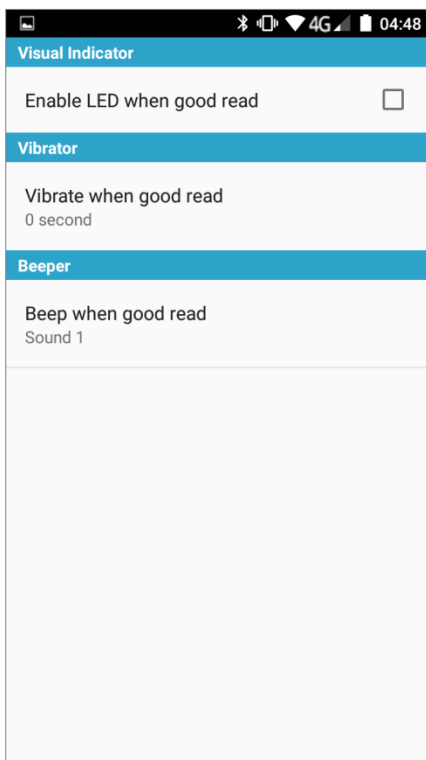

Setting		Description	Default
LED	Enable LED when good read	Selects to enable/disable LED light (left) for scanning good read. See Status LED for details.	Deselected (Disabled)
Vibrator	Vibrate when good read	Enables/disables tactile feedback (vibration) for good read and sets the duration to vibrate.	0 second (Disabled)
Beeper	Beep when good read	Sets the beeper sound for scanning good read. Users can choose to mute the beeper sound, or configure the beeper between sounds 1 to 9.	Sound 1

6.1.2. SYMBOLOGY

The **Symbology** page sets the symbologies to read, and also enables/disables some feature(s) for a symbology to read, such as:

- ▶ Customize and transmit start/stop characters
- ▶ Verify/transmit check digits
- ▶ Enable/disable addon digits
- ▶ Convert to another symbology
- ▶ Transmit symbology ID

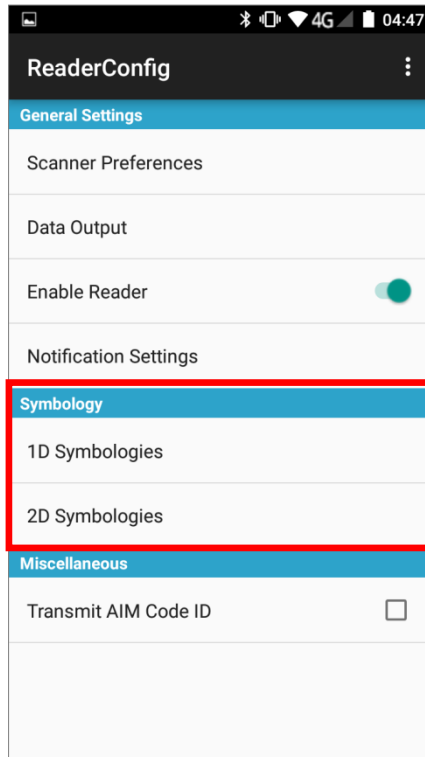

To open the **Symbology** settings page:

- 1) Open **ReaderConfig** as described in [Launch ReaderConfig](#).
- 2) Tap **1D Symbologies** or **2D Symbologies** (in case of a 2D imager) to list all symbologies which can be decoded.

1D Symbolologies

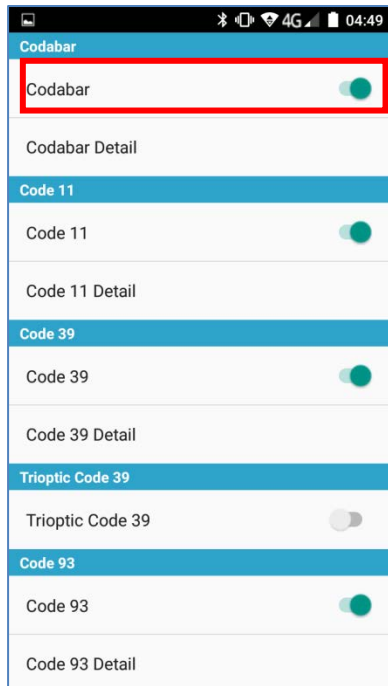

2D Symbolologies

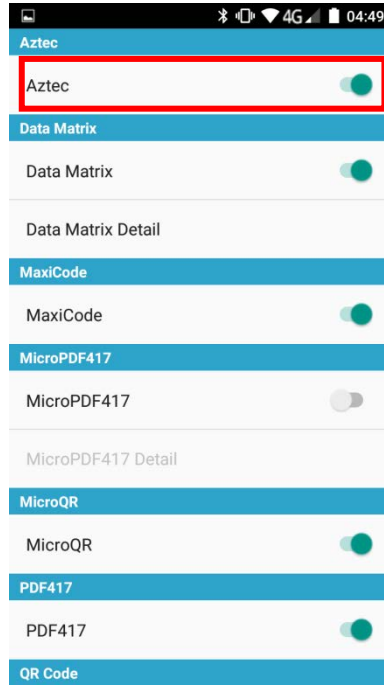

ENABLE/DISABLE SYMBOLOGY

Tap the label of each symbology to enable or disable it.

SYMBOLGY SETTINGS

Tap the **Detail** label below each symbology to access detailed settings for the specific symbology.

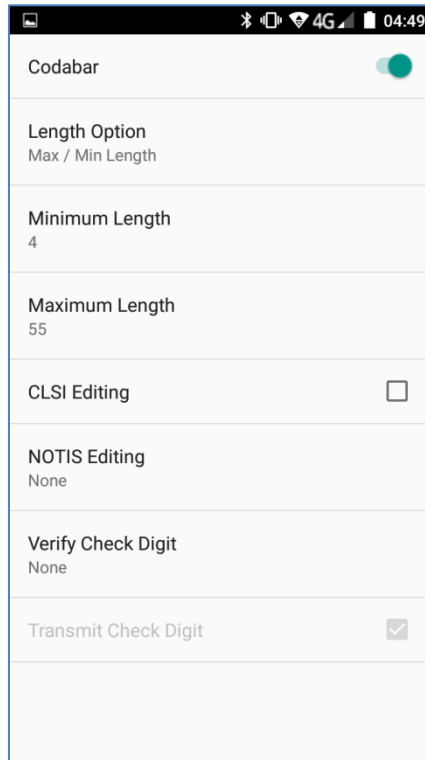
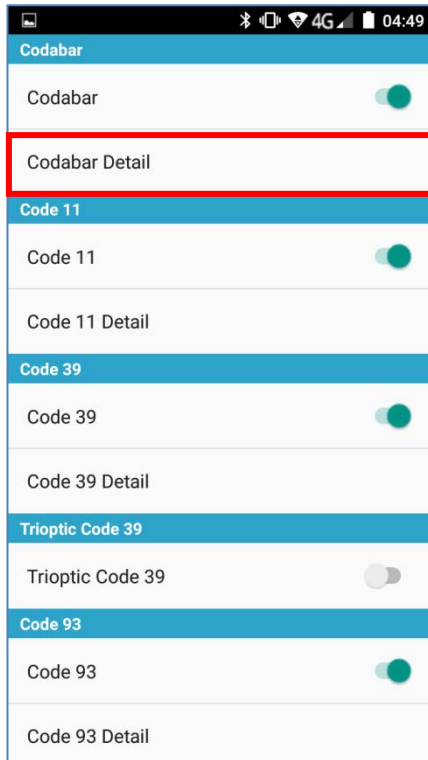

For details about the featured settings:

- ▶ See 2D Imager .

6.1.3. MISCELLANEOUS

This section allows enabling code ID transmission for easy identification of the scanned barcode.

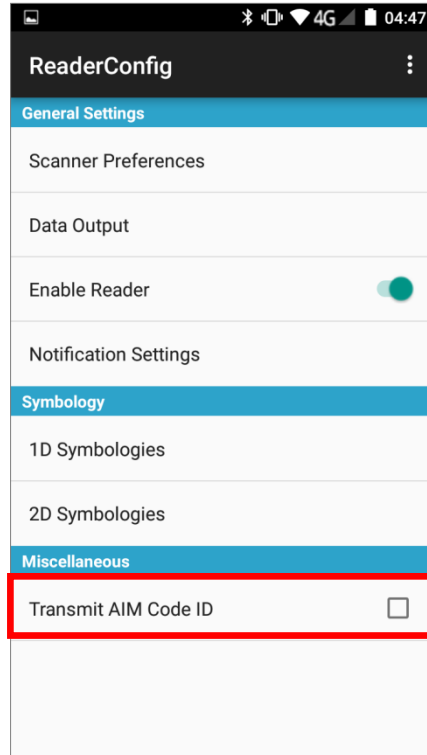

Setting	Description	Default
Transmit AIM Code ID	Sets whether to include AIM code ID character in the decoded data. For AIM code ID, see the following: 2D Imager Symbology Settings .	Deselected (Disabled)

6.1.4. READER CONFIG OPTION MENU

Reader Config provides an option menu which is accessible on the menu bar of the main settings page. This menu allows you to test scan barcodes, import/export all settings in a re-usable format, reset all settings back to factory default, and view copyright and version information.

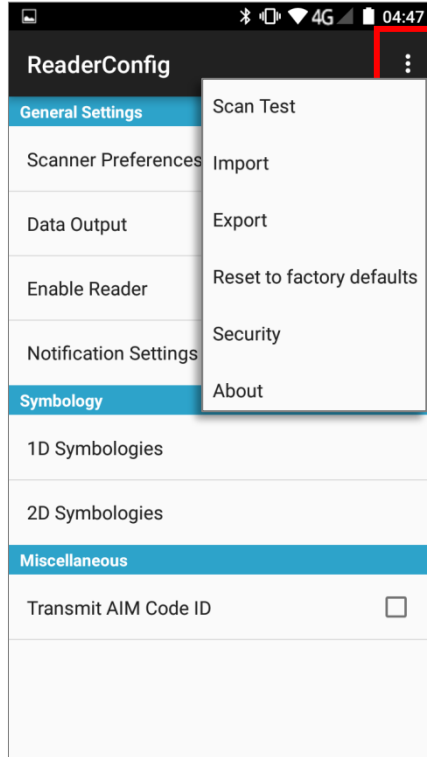

SCAN TEST

To test scan a barcode:

- 1) Open **Reader Config** as described in [Launch ReaderConfig](#).
- 2) Tap the settings button  on the menu bar to open the option menu.
- 3) Tap **Scan Test** in the option menu. A page opens for test scanning.

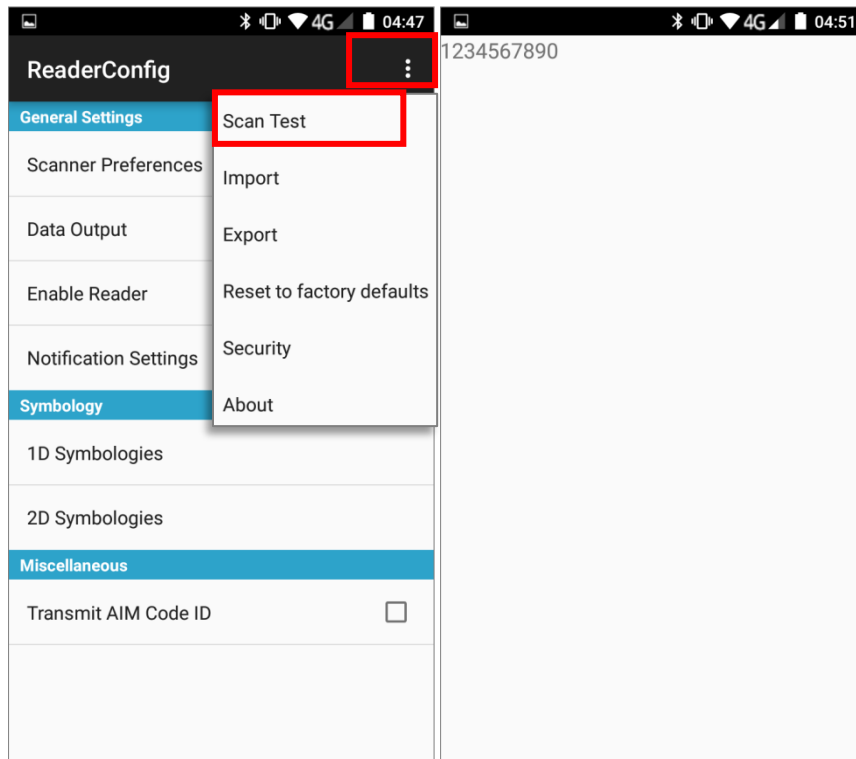

IMPORT AND EXPORT

Reader Config supports saving the settings and exporting them as an .xml file.

Previously exported symbology and scanner settings can be imported again on the mobile computer. This can also be used to implement identical Reader Config settings on multiple devices.

To import settings:

- 1) Open **Reader Config** as described in [Launch ReaderConfig](#).
- 2) Tap the settings button  on the menu bar to open the option menu.
- 3) Tap **Import** in the option menu.

A page opens allowing you to select a previously saved profile.

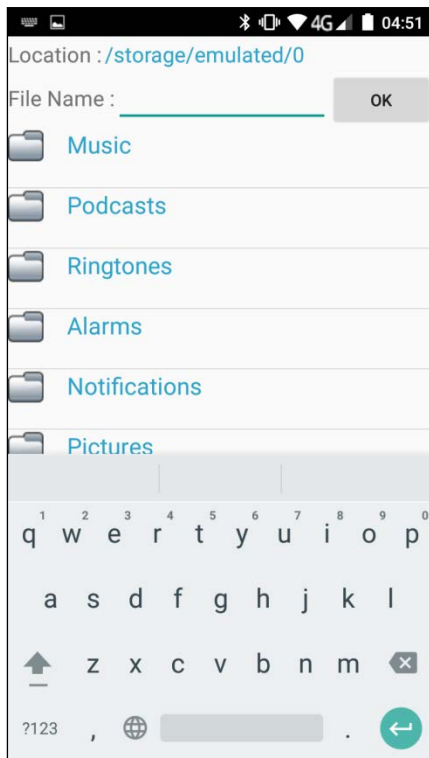

- 4) Tap **OK**. In a few seconds a prompt will appear on the mobile computer to indicate settings have been imported successfully.

To export settings:

- 1) Open **Reader Config** as described in [Launch ReaderConfig](#).
- 2) Tap the settings button  on the menu bar to open the option menu.
- 3) Tap **Export**.
- 4) An export page opens allowing you to enter the name and location of the profile to save.

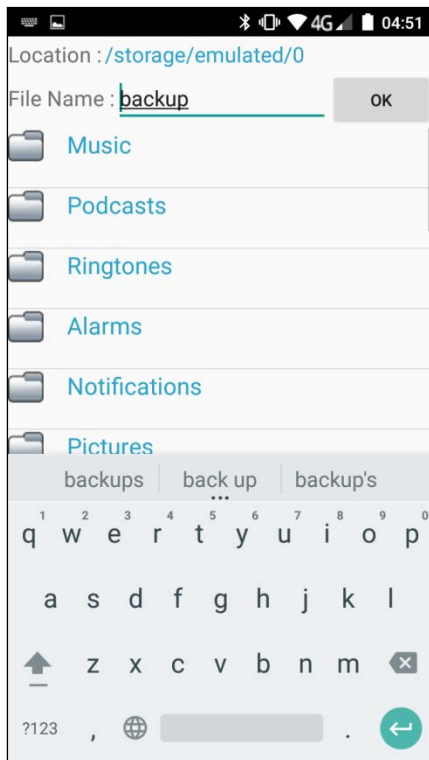

- 5) Tap **OK** to export. A prompt will appear on-screen to notify that settings have been exported.

RESET TO FACTORY DEFAULTS

This function restores all settings in the **Reader Config** application to default.

To enable Factory Reset:

- 1) Open **Reader Config** as described in [Launch ReaderConfig](#).
- 2) Tap the settings button  on the menu bar to open the option menu.
- 3) Tap **Reset to Factory defaults**.
- 4) A warning dialog appears confirming whether to restore all application settings back to default. Tap **OK** to reset or **Cancel** to close the dialog.

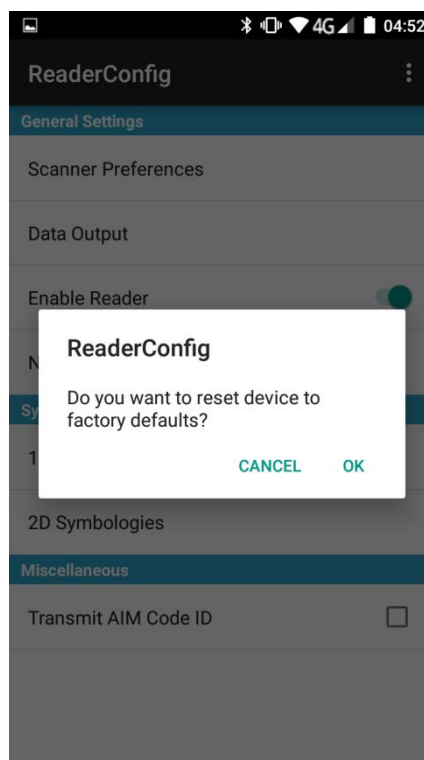
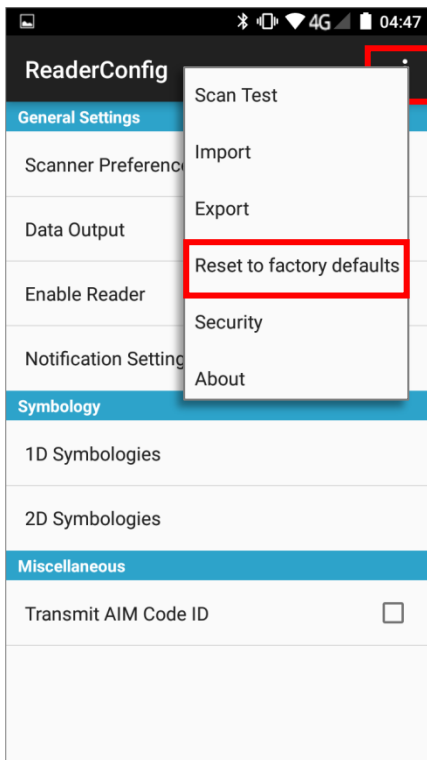

SECURITY

You can set a password to restrict other users of this mobile computer from changing certain configurations or accessing certain functions in Reader Config.

- 1) Open **Reader Config** as described in [Launch ReaderConfig](#).
- 2) Tap the settings button  on the menu bar to open the option menu.
- 3) Tap **Security**.
- 4) Enter and confirm a password (up to 32 characters, containing at least 1 digit or 1 alphabetic letter).
- 5) Check the items that will be protected by this password.

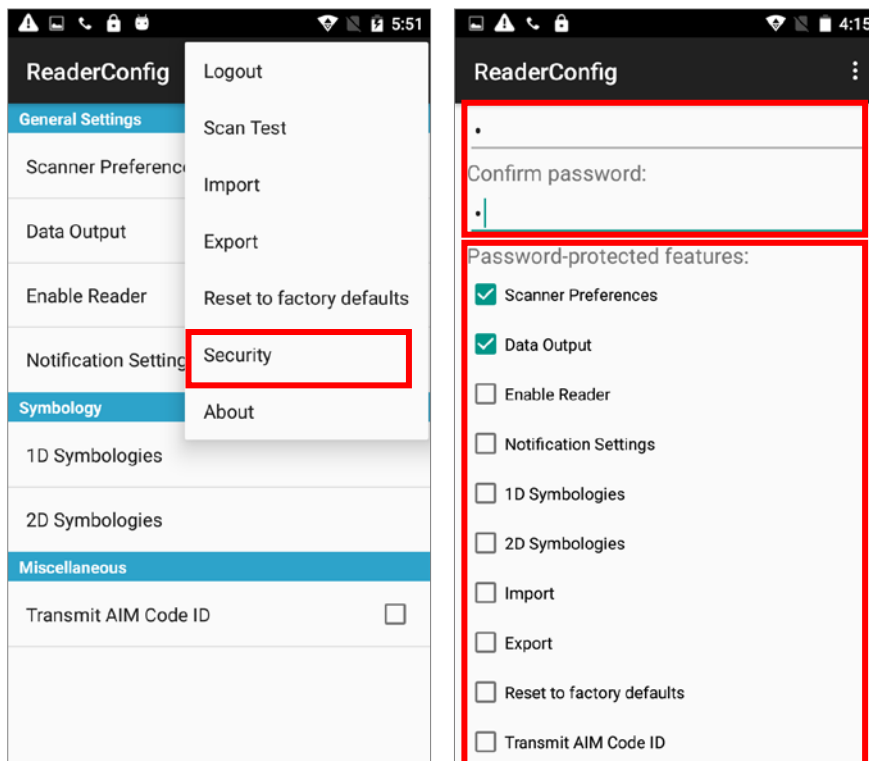

ABOUT

Tap **About** in the Reader Config option menu to display software version and copyright information.

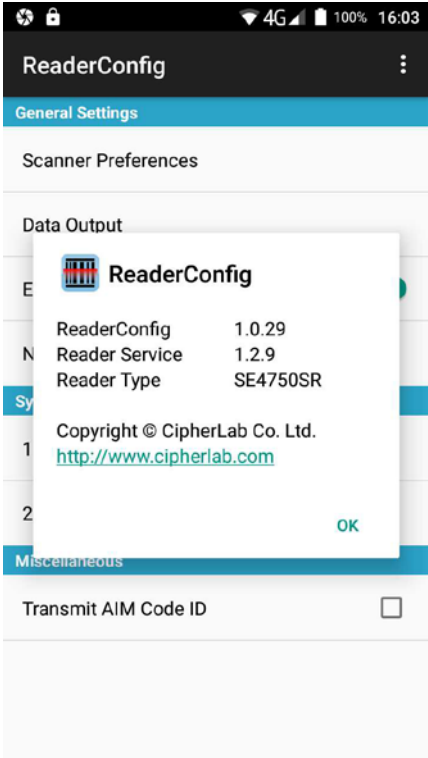

6.2. READ PRINTED BARCODES

Aside from output to destinations as per [Keyboard Emulation](#) settings, Reader Config provides a **Scan Test** feature for quick viewing of decoded data.

To perform test scanning of barcodes:

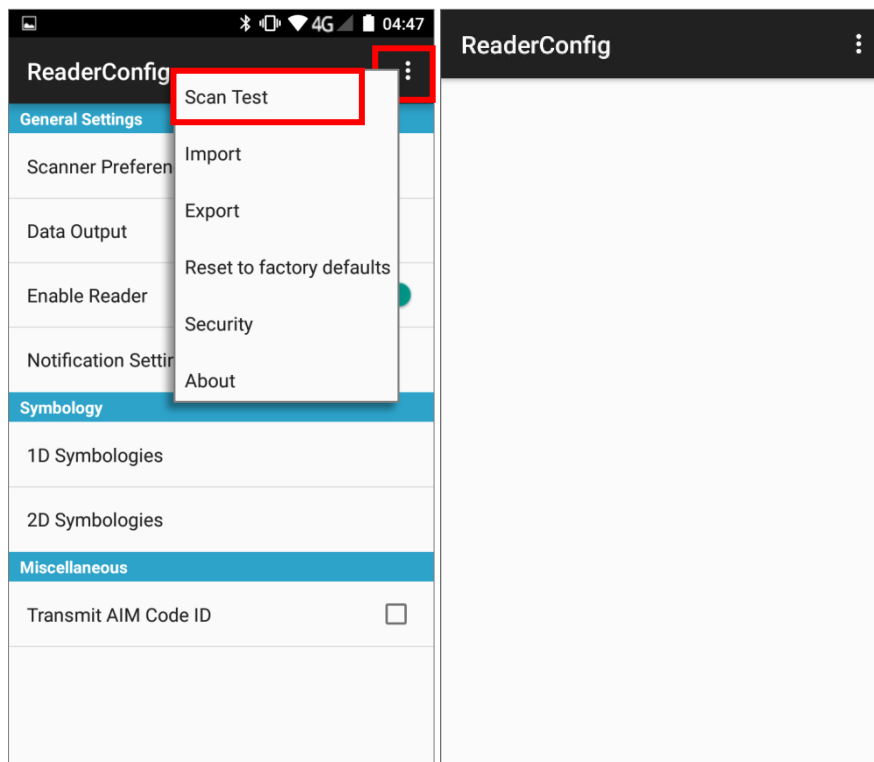

- 1) Open **Reader Config** as described in [Launch ReaderConfig](#).
- 2) Tap the settings button  on the menu bar to open the option menu.
- 3) Tap **Scan Test** on the menu bar.

A Test Scan Form opens for displaying the scanned data.

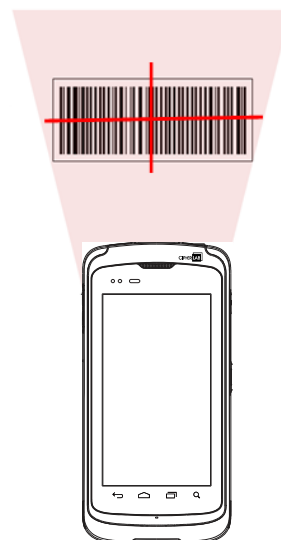

- 4) Aim the scanning window at the barcode to read and press any of the two side triggers. The scanning light beams to read the printed barcodes. The scanning light goes off once the data is decoded, or when the decode timeout period has passed.



The decoded data will appear on the page. When finished viewing, tap  to leave the test scan page; or tap the settings button  and then **“Save”** to save the decoded data as a .txt file or **“Clear All”** to clear all data on the screen.

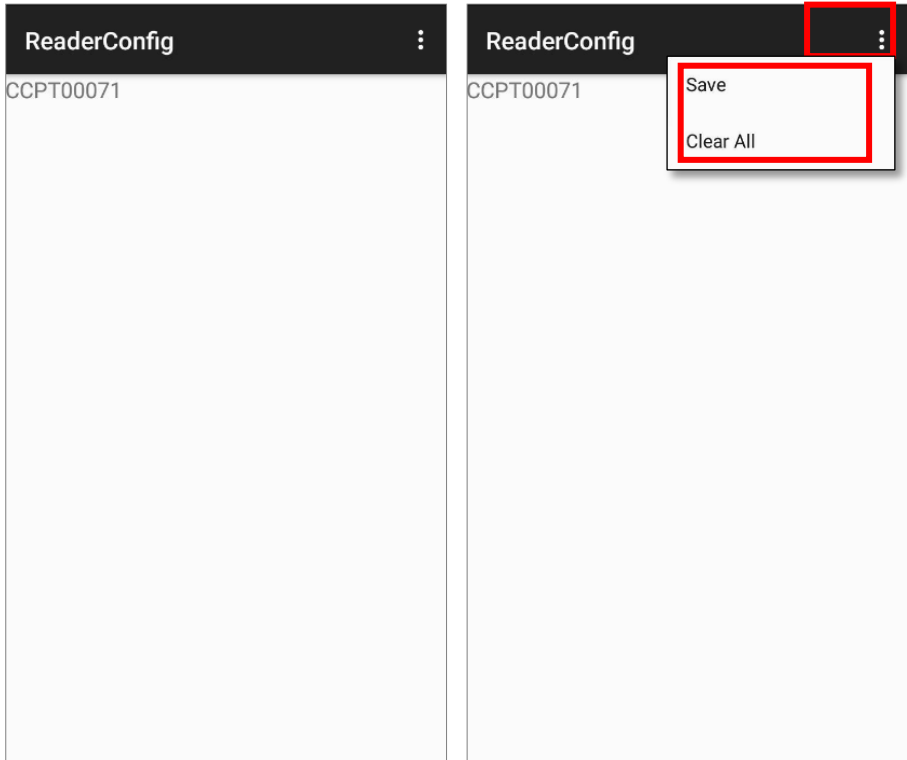

SPECIFICATIONS

PLATFORM, PROCESSOR & MEMORY

Operating System & CPU

OS Version	Android™ 6.0 Marshmallow with GMS Certified
CPU	Cortex A53 Octa-core 2.0GHz

Memory

ROM	16GB
RAM	2GB
Expansion Slot	One microSD card slot (up to 32GB for SDHC; up to 2TB for SDXC)

COMMUNICATION & DATA CAPTURE

Communication

USB Client	USB 2.0 OTG
WPAN	Bluetooth Class II, v4.1 and v2.1+EDR (2402~2480 MHz: 3.3dBm)
WLAN	IEEE 802.11 a/b/g/n/ac networking (2412~2472 MHz: 18.41dBm 5180~5240MHz: 21.06dBm, 5260~5320MHz: 21.46dBm, 5500~5700MHz: 21.90dBm)
WWAN	Built-in WWAN modem for Quadband GSM, UMTS, LTE functions: GSM/GPRS/EDGE/WCDMA/UMTS/HSDPA/HSUPA/HSPA+/LTE Worldwide Frequency bands: GSM/GPRS/EDGE 880~915, 925~960MHz: 33dBm 1710~1785, 1805~1880MHz: 30dBm WCDMA/UMTS/HSDPA/HSUPA: B1(2100),B8(900) 1920~1980, 2110~2170: 24dBm 880~915, 925~960: 24dBm LTE FDD: B1(2100),B3(1800),B7(2600),B8(900),B20(800),B38(2600) 1920~1980, 2110~2170MHz: 23dBm 1710~1785, 1805~1880MHz: 23dBm 2500~2570, 2620~2690MHz: 23dBm 880~915, 925~960MHz: 23dBm 832~862, 791~821MHz: 23dBm 2570~2620MHz: 23dBm Americas GSM : 850/900/1800/1900 UMTS : 850/900/AWS(1700)/1900/2100 FDD LTE : 700/850/1700/1900/2600 (FDD 13,17,5,4,2,7)
GPS	Built-in GPS with AGPS support, ephemeris downloadable (1575.42MHz)

Data & Image Capture

Digital Camera	Autofocus 8 megapixels (F2.0) with user-controllable flash
Barcode Reader	2D Imager
HF RFID Reader	HF RFID 13.56 MHz (-3.80 dBuA/m at 10m) frequency which supports ISO14443A, ISO14443B, ISO15693, Felica Supports NFC (Peer-to-Peer, Card Reader, Card Emulation)

ELECTRICAL CHARACTERISTICS

Batteries

Main Battery Pack	Replaceable and rechargeable 3.8V 4000 mAh or 3.8V 5300 mAh Li-ion battery
Backup Battery	Rechargeable Li-ion battery: 3.7V, 60 mAh Capable of Data retention for 30 minutes Charging time: 4 hours

Power Adaptor

Power Supply Cord with Universal Power Adaptor	Input	AC 100~240 V, 50/60 Hz
	Output	DC 5V, 2A BSMI, CCC, FCC, CE, RCM, PSE, PSB

Working Time

Supports working time for up to 12/16 (4000/5300 mAh main battery) hours at 25 degrees

PHYSICAL CHARACTERISTICS

Color Touch Screen Display

Display	4.7" capacitive touch supports bare/wet/gloved finger and stylus inputs
Resolution	HD (720x 1280 pixels)

Notifications

Status LED	Two front LED indicators signaling charging and data capturing status
Audio	Integrated with one speaker playing sounds for events
Vibrator	Integrated with one vibrator for tactile feedback

Dimensions & Weight

Dimensions	162 mm (L) x 80mm (W) x 26mm (H)
Weight	330g (equipped with 4000mAh battery) 365g (equipped with 5300mAh battery)

ENVIRONMENTAL CHARACTERISTICS

Temperature

Operating	-20°C to 50°C (-4°F to 122°F)
Storage	-30°C to 70°C (-22°F to 158°F)
Charging	0°C to 35°C

Humidity

Operating	10% to 90% (non-condensing)
Storage	5% to 95% (non-condensing)

Resistance

Impact Resistance	Multiple drops onto concrete at 1.8 m (6 ft.) on all six sides
Tumble Test	1000 tumbles (2000 drops) at 1 m
Splash/Dust Resistance	IP65/IP67
Electrostatic Discharge	±15 kV air discharge, ±8 kV contact discharge

PROGRAMMING SUPPORT

Development Environment & Tools

JAVA	Environment Android studio Software Development Kit: JAR
C#	Environment: Visual Studio 2015 or later Software Development Kit: DLL (Xamarin Library)

Software & Utilities

Software Package	Reader Configuration MDS Software Trigger Key Xamarin Binding CipherLab TE App-Lock HTML5 (Browser and API) SOTI MobiControl Kalipso
------------------	--

APPENDIX I

SCAN ENGINE SETTINGS

Reader Configuration sets the following reader types:

- ▶ 2D Imager

SYMBOLOGIES SUPPORTED

Depending on the scan engine integrated on the mobile computer, supported symbologies will differ as listed below. For details on configuring associated settings, refer to [Appendix II](#).

		2D
Codabar		✓
Code 11		✓
Code 39	Code 39	✓
	Trioptic Code 39	✓
	Italian Pharmacode (Code 32)	✓
Code 93		✓
Code 128	Code 128	✓
	GS1-128 (EAN-128)	✓
	ISBT 128	✓
Code 2 of 5	Chinese 25	✓
	Industrial 25 (Discrete 25)	✓
	Interleaved 25	✓
	Convert Interleaved 25 to EAN-13	✓
	Matrix 25	✓
Composite Code	Composite CC-A/B	✓
	Composite CC-C	✓
	Composite TLC 39	✓
GS1 DataBar (RSS)	GS1 DataBar-14 (RSS-14)	✓
	GS1 DataBar Limited (RSS Limited)	✓
	GS1 DataBar Expanded (RSS Expanded)	✓
	Convert to UPC/EAN	✓
Korean 3 of 5		✓
MSI		✓
Postal Codes	Australian Postal	✓
	Japan Postal	✓

	Netherlands KIX Code	✓
	US Postnet	✓
	US Planet	✓
	USPS Postal	✓
	UPU FICS Postal	✓
	UK Postal	✓
EAN/UPC	EAN-8	✓
	EAN-8 Extend	✓
	EAN-13	✓
	Bookland EAN (ISBN)	✓
	ISSN EAN	✓
	UPC-A	✓
	UPC-E	✓
	Convert to UPC-A	✓
	UPC-E1	✓
	Convert to UPC-A	✓
Coupon Code		✓
2D Symbologies	Aztec	✓
	Data Matrix	✓
	Maxicode	✓
	MacroPDF	✓
	MicroPDF417	✓
	MicroQR	✓
	PDF417	✓
	QR Code	✓

APPENDIX II

2D IMAGER

The tables below list the symbology settings for 2D imager.

SYMBOLGY SETTINGS

1D SYMBOLOGIES

Symbology	Description	Default
CODABAR		
CodaBar		Enable
Codabar	Switch to enable Codabar decoding.	Enable
Length option	Sets the length of the Codabar symbols to decode. <ul style="list-style-type: none"> ▶ One Fixed length (Length 1) ▶ Two Fixed lengths (Length 1>Length 2) ▶ Max / Min Length (range: 0-55; Length 1<Length 2) ▶ Any Length 	Max / Min Length (4-55)
CLSI Editing	When applied, the CLSI editing strips the start/stop characters and inserts a space after the first, fifth, and tenth characters of a 14-character Codabar barcode. <ul style="list-style-type: none"> ▶ The 14-character barcode length does not include start/stop characters. 	Disable
NOTIS Editing	Sets whether to include start/stop characters in the transmitted data. <ul style="list-style-type: none"> ▶ NOTIS Editing is to strip the start/stop characters, i.e. to disable "Transmit Start/Stop Characters". 	Disable
NOTIS Editing Type	Options are None, ABCD/ABCD, abcd/abcd. "NOTIS Editing" must be enabled.	None
Verify Check Digit	Selects whether to verify the Modulo 43 check digit. If the check digit is incorrect, the barcode will not be accepted.	None

Transmit Check Digit	Decide whether to include the check digit in the data to transmit. "Verify Check Digit" must be enabled.	Enable
CODE 11		
Code 11		Enable
Code 11	Switch to enable Code 11 decoding.	Enable
Check Digit Option	Sets whether to verify check digits according to the selected option. If the check digits are incorrect, the barcode will not be accepted. <ul style="list-style-type: none"> ▶ Disable ▶ One Check Digit ▶ Two Check Digits 	Disable
Transmit Check Digit	Selects whether to include check digits in the transmitted data. <ul style="list-style-type: none"> ▶ Check Digit Option" must be enabled. 	Disable
Length option	Sets the length of the Code 11 symbols to decode. <ul style="list-style-type: none"> ▶ One Fixed length (Length 1) ▶ Two Fixed lengths (Length 1>Length 2) ▶ Max / Min Length (range: 0-55; Length 1<Length 2) ▶ Any Length 	Max / Min Length (4-55)
CODE 39		
Code 39		Enable
Code 39	Switch to enable Code 39 decoding.	Enable
Trioptic Code 39	Selects whether to decode Trioptic Code 39. <ul style="list-style-type: none"> ▶ Trioptic Code 39 is a variant of Code 39 used in the marking of computer tape cartridges. It always contains six characters. 	Disable
Convert to Code 32	Selects whether to convert decoded data to Italian Pharmacode.	Disable
Code 32 Prefix	Prefix character "A" to Code 32 barcodes. <ul style="list-style-type: none"> ▶ "Convert to Code 32" must be enabled for this to function properly. 	Disable
Verify Check Digit	Selects whether to verify the Modulo 43 check digit. If the check digit is incorrect, the barcode will not be accepted.	Disable

Transmit Check Digit	Decide whether to include the check digit in the data to transmit. <ul style="list-style-type: none"> ▶ “Verify Check Digit” must be enabled. 	Disable
Support Full ASCII	Selects whether to enable Code 39 Full ASCII decoding. Characters are paired to encode the full ASCII character set.	Disable
Length option	Sets the length of the Code 39 symbols to decode. <ul style="list-style-type: none"> ▶ One Fixed length (Length 1) ▶ Two Fixed lengths (Length 1>Length 2) ▶ Max / Min Length (range: 0-55; Length 1<Length 2) ▶ Any Length 	Max / Min Length (4-55)
CODE 93		
Code 93		Enable
Code 93	Switch to enable Code 93 decoding.	Enable
Length option	Sets the length of the Code 93 symbols to decode. <ul style="list-style-type: none"> ▶ One Fixed length (Length 1) ▶ Two Fixed lengths (Length 1>Length 2) ▶ Max / Min Length (range: 0-55; Length 1<Length 2) ▶ Any Length 	Max / Min Length (4-55)
CODE 128		
Code 128		Enable
Code 128	Switch to enable Code 128 decoding.	Enable
GS1-128		Enable
GS1-128	▶ Switch to enable GS1-128 decoding.	Enable
Separator Character	▶ Enable the function code character separator, which is used to separate data fields of variable length and application identifiers of subsequent data fields in concatenated data strings. Choose your input method from drop-list: Keyboard input , Keyboard input (Hexadecimal) or Symbol table input to set a separator character to replace with.	None

Enable App ID Separator	<p>▶ Check to enable the separator configuration for Application Identifier.</p>  <p>▶ You can respectively set the Left Separator and Right Separator. Choose your input method from drop-down list: Keyboard input, Keyboard input (Hexadecimal) or Symbol table input to set a separator character to replace with.</p>	
ISBT-128		Enable
ISBT 128	Switch to enable ISBT 128 decoding.	Enable
Concatenation	<p>Sets whether to enable decoding ISBT-128 by performing concatenation of ISBT data</p> <ul style="list-style-type: none"> ▶ Disable: Does not perform concatenation ▶ Enable: Performs concatenation on all ISBT-128 barcodes. ▶ Auto-discriminate: Auto-discriminates between the ISBT-128 barcodes which require concatenation and those which do not need concatenation. 	Auto-discriminate
Redundancy	When “Auto-discriminate” is applied, decide the number of times of supplementary decoding the same barcode to count as a valid read. Configurable between 2 and 20	10
CODE 2 OF 5		

Chinese 25		Enable
Chinese 25	Switch to enable Chinese 2 of 5 decoding.	Enable
Discrete 25		Enable
Discrete 25	Switch to enable Discrete 2 of 5 decoding.	Enable
Length option	<p>Sets the length of the Discrete 2 of 5 symbols to decode.</p> <ul style="list-style-type: none"> ▶ One Fixed length (Length 1) ▶ Two Fixed lengths (Length 1>Length 2) ▶ Max / Min Length (range: 0-55; Length 1<Length 2) ▶ Any Length 	Max / Min Length (4-55)
Interleaved 25		Enable
Interleaved 25	Switch to enable Interleaved 2 of 5 decoding.	Enable
Length option	<p>Sets the length of the Interleaved 2 of 5 symbols to decode.</p> <ul style="list-style-type: none"> ▶ One Fixed length (Length 1) ▶ Two Fixed lengths (Length 1>Length 2) ▶ Max / Min Length (range: 0-55; Length 1<Length 2) ▶ Any Length 	Max / Min Length (4-55)
Verify Check Digit	<p>Decide whether to verify the check digit. If desired, select one of the algorithms below. If the check digit is incorrect, the barcode will not be accepted.</p> <ul style="list-style-type: none"> ▶ Disable ▶ USS Check Digit ▶ OPCC Check Digit 	Disable
Transmit Check Digit	Decide whether to include the check digit in the data being transmitted.	Disable
Convert To EAN-13	<p>Convert a 14-character Interleaved 25 barcode into EAN-13 if the following requirements are met:</p> <ul style="list-style-type: none"> ▶ The barcode must have a leading 0 and a valid EAN-13 check digit. 	Disable
Matrix 25		Enable
Matrix 25	Switch to enable Matrix 2 of 5 decoding.	Enable
Length option	<p>Sets the length of the Matrix 2 of 5 symbols to decode.</p> <ul style="list-style-type: none"> ▶ One Fixed length (Length 1) ▶ Two Fixed lengths (Length 1>Length 2) ▶ Max / Min Length (range: 0-55; Length 1<Length 2) ▶ Any Length 	Max / Min Length (4-55)
Redundancy	Enables or disable read redundancy for Matrix 2 of 5.	Disable
Verify Check Digit	Select whether to verify the check digit, which is the last character of the barcode. If the check digit is incorrect, the barcode will not be accepted.	Disable
Transmit Check Digit	Decide whether to include the check digit in the data being transmitted.	Disable

COMPOSITE		
Composite CC-A/B		Disable
Composite CC-A/B	Switch to enable Composite CC-A/B decoding.	Disable
Composite CC-C		Enable
Composite CC-C	Switch to enable Composite CC-C decoding.	Enable
Composite TLC 39		Disable
Composite TLC 39	Switch to enable Composite TLC 39 decoding.	Disable
Composite General Preference		
UPC Composite Mode	<p>UPC barcodes can be "linked" with a 2D barcode during transmission as if they were one barcode.</p> <hr/> <p>UPC Never Linked</p> <p>Transmit UPC barcodes regardless of whether a 2D barcode is detected.</p> <hr/> <p>UPC Always Linked</p> <p>Transmit UPC barcodes and the 2D portion. If the 2D portion is not detected, the UPC barcode will not be transmitted.</p> <p>▶ CC-A/B or CC-C must be enabled.</p> <hr/> <p>Auto-discriminate</p> <p>Transmit UPC barcodes as well as the 2D portion if present.</p>	UPC always Linked
GS1-128 Emulation Mode	Sets GS1-128 emulation mode for UCC/EAN Composite Codes.	Disable
GS1 DATABAR		
GS1 DataBar-14		Enable
GS1 DataBar-14	Switch to enable GS1 DataBar-14 decoding.	Enable
Convert to UPC/EAN	Strips the leading '010' of GS1 DataBar and converts the barcode to EAN-13.	Disable
Security Level	A value that specifies the decode security level while reading GS1 DataBar 14 from Level 0 to 3.	Level 1
GS1 DataBar Limited		Enable
GS1 DataBar Limited	Switch to enable GS1 DataBar Limited decoding.	Enable
Convert to UPC/EAN	Strips the leading '010' of GS1 DataBar Limited and converts the barcode to EAN-13.	Disable
Security Level	There are setting options from Level 1 to 4.	Level 3
GS1 DataBar Expanded		Enable
GS1 DataBar Expanded	Switch to enable GS1 DataBar Expanded decoding.	Enable
Separator Character	Enable the function code character separator, which is used to separate data fields of variable length and application identifiers of subsequent data fields in concatenated data strings.	None

Security Level	There are setting options from Level 0 to 3	Level 1
KOREAN 3 OF 5		
Korean 3 of 5		Disable
MSI		
MSI		Enable
MSI	Switch to enable MSI decoding.	Enable
Length option	<p>Sets the length of the MSI symbols to decode.</p> <ul style="list-style-type: none"> ▶ One Fixed length (Length 1) ▶ Two Fixed lengths (Length 1>Length 2) ▶ Max / Min Length (range: 0-55; Length 1<Length 2) ▶ Any Length 	Max / Min Length (4-55)
Verify Check Digit	<p>One check digit is mandatory for decoding MSI barcodes. Select whether a second check digit should be verified. If the check digits are incorrect, the barcode will not be accepted.</p> <ul style="list-style-type: none"> ▶ One Check Digit ▶ Two Check Digits 	One Check Digit
Transmit Check Digit	Decide whether to include the check digit in the data being transmitted.	Disable
Algorithm	<p>When two check digits are set for verification, two choices are available for the pair of check digits.</p> <ul style="list-style-type: none"> ▶ Modulo10 / Modulo11 ▶ Double Modulo 10 	Double Modulo 10
POSTAL CODE		
Australian Postal		Enable
Japan Postal		Enable
Netherlands KIX Code		Enable
US Postnet		Enable
US Planet		Enable
USPS Postal		Enable
UPU FICS Postal		Enable
UK Postal		Enable
Postal General Preference		Enable
US Postal Check Digit	Decide whether to transmit check digit for US Postnet or US Planet.	Enable
UK Postal Check Digit	Decide whether to transmit check digit for UK Postal.	Enable
UPC/EAN		
EAN-8		Enable
EAN-8	Switch to enable EAN-8 decoding.	Enable

Addon 2	Decide whether to decode EAN-8 with addon 2. <ul style="list-style-type: none"> ▶ Ignore Addon ▶ Auto-discriminate 	Ignore addon
Addon 5	Decide whether to decode EAN-8 with addon 5. <ul style="list-style-type: none"> ▶ Ignore Addon ▶ Auto-discriminate 	Ignore addon
Transmit Check Digit	Decide whether to include the check digit in the data being transmitted.	Enable
Convert to EAN-13	Checkbox to enable converting EAN-8 to EAN-13 format.	Disable
EAN-13		Enable
EAN-13	Switch to enable EAN-13 decoding.	Enable
Bookland EAN	Checkbox to enable ISBN decoding. If enabled, select Bookland ISBN Format in the drop-down box below.	Disable
Bookland ISBN Format	Decodes Bookland data starting with 978 in 10-digit format along with the Bookland check digit, or Bookland data starting with 978/979 in 13-digit format.	Bookland ISBN-10
Addon 2	Decide whether to decode EAN-13 with addon 2. <ul style="list-style-type: none"> ▶ Ignore Addon ▶ Auto-discriminate 	Ignore addon
Addon 5	Decide whether to decode EAN-13 with addon 5. <ul style="list-style-type: none"> ▶ Ignore Addon ▶ Auto-discriminate 	Ignore addon
Transmit Check Digit	Decide whether to include the EAN-13 check digit (the last character in the barcode) in the data being transmitted.	Enable
ISSN EAN	Checkbox to enable ISSN EAN decoding.	Disable
UPC-A		Enable
UPC-A	Switch to enable UPC-A decoding.	Enable
Addon 2	Decide whether to decode UPC-A with addon 2. <ul style="list-style-type: none"> ▶ Ignore Addon ▶ Auto-discriminate 	Ignore addon
Addon 5	Decide whether to decode UPC-A with addon 5. <ul style="list-style-type: none"> ▶ Ignore Addon ▶ Auto-discriminate 	Ignore addon
Preamble	Decide whether to include the UPC-A preamble System Character (and Country Code) in the data being transmitted. <ul style="list-style-type: none"> ▶ No transmit: transmits none of the above ▶ Transmit System Character: transmits system number only ▶ Transmit Sys. Character and Country Code: transmits system number and country code 	Transmit System Character
Transmit Check Digit	Decide whether to include the UPC-A check digit (the last character in the barcode) in the data being transmitted.	Enable
Convert to EAN-13	Checkbox to enable converting EAN-8 to EAN-13 format.	Disable
UPC-E		Enable

UPC-E	Switch to enable UPC-E decoding.	Enable
Addon 2	Decide whether to decode UPC-E with addon 2. <ul style="list-style-type: none"> ▶ Ignore Addon ▶ Auto-discriminate 	Ignore addon
Addon 5	Decide whether to decode UPC-E with addon 5. <ul style="list-style-type: none"> ▶ Ignore Addon ▶ Auto-discriminate 	Ignore addon
Preamble	Decide whether to include the UPC-E preamble System Character (and Country Code) in the data being transmitted. <ul style="list-style-type: none"> ▶ No transmit: transmits none of the above ▶ Transmit System Character: transmits system number only ▶ Transmit Sys. Character and Country Code: transmits system number and country code 	Transmit System Character
Convert to UPC-A	The UPC-E barcode will be expanded into UPC-A format, and the next process will follow the settings configured for UPC-A.	Disable
Transmit Check Digit	Decide whether to include the UPC-E1 check digit (the last character in the barcode) in the data being transmitted.	Enable
UPC-E1		Disable
UPC-E1	Switch to enable UPC-E1 decoding.	Disable
Addon 2	Decide whether to decode UPC-E1 with addon 2. <ul style="list-style-type: none"> ▶ Ignore Addon ▶ Auto-discriminate 	Ignore addon
Addon 5	Decide whether to decode UPC-E1 with addon 5. <ul style="list-style-type: none"> ▶ Ignore Addon ▶ Auto-discriminate 	Ignore addon
Preamble	Decide whether to include the UPC-E1 preamble System Character (and Country Code) in the data being transmitted. <ul style="list-style-type: none"> ▶ No transmit: transmits none of the above ▶ Transmit System Character: transmits system number only ▶ Transmit Sys. Character and Country Code: transmits system number and country code 	Transmit System Character
Convert to UPC-A	The UPC-E1 barcode will be expanded into UPC-A format, and the next process will follow the settings configured for UPC-A.	Disable
Transmit Check Digit	Decide whether to include the UPC-E1 check digit (the last character in the barcode) in the data being transmitted.	Enable
Coupon Code		
Coupon Code	Switch to enable Coupon Code decoding.	Disable

2D SYMBOLOGIES

Symbology	Description	Default						
Aztec		Enable						
Aztec	Switch to enable Aztec decoding.	Enable						
Data Matrix		Enable						
Data Matrix	Switch to enable Data Matrix decoding.	Enable						
Decode Mirror Image	<p>Switch to enable decode mirror images.</p> <table border="1"> <tr> <td>Never</td> </tr> <tr> <td>Does not decode Data Matrix barcodes that are mirror images.</td> </tr> <tr> <td>Always</td> </tr> <tr> <td>Decodes Data Matrix barcodes that are mirror images.</td> </tr> <tr> <td>Auto</td> </tr> <tr> <td>Decodes both mirrored and unmirrored Data Matrix barcodes.</td> </tr> </table>	Never	Does not decode Data Matrix barcodes that are mirror images.	Always	Decodes Data Matrix barcodes that are mirror images.	Auto	Decodes both mirrored and unmirrored Data Matrix barcodes.	Never
Never								
Does not decode Data Matrix barcodes that are mirror images.								
Always								
Decodes Data Matrix barcodes that are mirror images.								
Auto								
Decodes both mirrored and unmirrored Data Matrix barcodes.								
Separator Character	Enable the function code character separator, which is used to separate data fields of variable length and application identifiers of subsequent data fields in concatenated data strings.	None						
Maxicode		Enable						
MicroPDF417		Disable						
MicroPDF417	Switch to enable MicroPDF417 decoding.	Disable						
Code 128 Emulation	<p>Transmit data from certain Micro PDF 417 barcodes as if it was encoded in Code 128 barcodes.</p> <ul style="list-style-type: none"> Transmit AIM code ID character in Miscellaneous options must be enabled first. <p>When applied, the MicroPDF417 barcodes are transmitted with one of these prefixes:</p> <table border="1"> <tr> <td>The first codeword of MicroPDF417 is 903-905:</td> </tr> <tr> <td>The original Code ID "]L3" will be changed to "]C1".</td> </tr> <tr> <td>The first codeword of MicroPDF417 is 908 or 909:</td> </tr> <tr> <td>The original Code ID "]L4" will be changed to "]C2".</td> </tr> </table>	The first codeword of MicroPDF417 is 903-905:	The original Code ID "]L3" will be changed to "]C1".	The first codeword of MicroPDF417 is 908 or 909:	The original Code ID "]L4" will be changed to "]C2".	Disable		
The first codeword of MicroPDF417 is 903-905:								
The original Code ID "]L3" will be changed to "]C1".								
The first codeword of MicroPDF417 is 908 or 909:								
The original Code ID "]L4" will be changed to "]C2".								

	<p>The first codeword of MicroPDF417 is 910 or 911:</p> <p>The original Code ID "]L5" will be changed to "]C0".</p>	
MicroQR		Enable
PDF417		Enable
QR Code		Enable
QR Code	Switch to enable QR Code decoding.	Enable

MISCELLANEOUS

2D Engine	Description	Default
Miscellaneous Options		
Transmit AIM Code ID	<p>Decide whether to include AIM Code ID in the data.</p> <p>Each AIM Code ID contains a three-character string "]cm":</p> <ul style="list-style-type: none"> ▶] = Flag Character (ASCII 93) ▶ c = Code Character ▶ m = Modifier Character ▶ Refer to AIM Code ID. 	Disable

APPENDIX III

OPEN SOURCE LICENSE

The Reader Config involves the android-serialport-api project of Apache License Version 2.0, January 2004.

<http://www.apache.org/licenses/>

TERMS AND CONDITIONS FOR USE, REPRODUCTION, AND DISTRIBUTION

1. Definitions.

"License" shall mean the terms and conditions for use, reproduction, and distribution as defined by Sections 1 through 9 of this document.

"Licensor" shall mean the copyright owner or entity authorized by the copyright owner that is granting the License.

"Legal Entity" shall mean the union of the acting entity and all other entities that control, are controlled by, or are under common control with that entity. For the purposes of this definition, "control" means (i) the power, direct or indirect, to cause the direction or management of such entity, whether by contract or otherwise, or (ii) ownership of fifty percent (50%) or more of the outstanding shares, or (iii) beneficial ownership of such entity.

"You" (or "Your") shall mean an individual or Legal Entity exercising permissions granted by this License.

"Source" form shall mean the preferred form for making modifications, including but not limited to software source code, documentation source, and configuration files.

"Object" form shall mean any form resulting from mechanical transformation or translation of a Source form, including but not limited to compiled object code, generated documentation, and conversions to other media types.

"Work" shall mean the work of authorship, whether in Source or Object form, made available under the License, as indicated by a copyright notice that is included in or attached to the work (an example is provided in the Appendix below).

"Derivative Works" shall mean any work, whether in Source or Object form, that is based on (or derived from) the Work and for which the editorial revisions, annotations, elaborations, or other modifications represent, as a whole, an original work of authorship. For the purposes of this License, Derivative Works shall not include works that remain separable from, or merely link (or bind by name) to the interfaces of, the Work and Derivative Works thereof.

"Contribution" shall mean any work of authorship, including the original version of the Work and any modifications or additions to that Work or Derivative Works thereof, that is intentionally submitted to Licensor for inclusion in the Work by the copyright owner or by an individual or Legal Entity authorized to submit on behalf of the copyright owner. For the purposes of this definition, "submitted" means any form of electronic, verbal, or written communication sent to the Licensor or its representatives, including but not limited to communication on electronic mailing lists, source code control systems, and issue tracking systems that are managed by, or on behalf of, the Licensor for the purpose of discussing and improving the Work, but excluding communication that is conspicuously marked or otherwise designated in writing by the copyright owner as "Not a Contribution."

"Contributor" shall mean Licensor and any individual or Legal Entity on behalf of whom a Contribution has been received by Licensor and subsequently incorporated within the Work.

2. Grant of Copyright License. Subject to the terms and conditions of this License, each Contributor hereby grants to You a perpetual, worldwide, non-exclusive, no-charge, royalty-free, irrevocable copyright license to reproduce, prepare Derivative Works of, publicly display, publicly perform, sublicense, and distribute the Work and such Derivative Works in Source or Object form.

3. Grant of Patent License. Subject to the terms and conditions of this License, each Contributor hereby grants to You a perpetual, worldwide, non-exclusive, no-charge, royalty-free, irrevocable (except as stated in this section) patent license to make, have made, use, offer to sell, sell, import, and otherwise transfer the Work, where such license applies only to those patent claims licensable by such Contributor that are necessarily infringed by their Contribution(s) alone or by combination of their Contribution(s) with the Work to which such Contribution(s) was submitted. If You institute patent litigation against any entity (including a cross-claim or counterclaim in a lawsuit) alleging that the Work or a Contribution incorporated within the Work constitutes direct or contributory patent infringement, then any patent licenses granted to You under this License for that Work shall terminate as of the date such litigation is filed.

4. Redistribution. You may reproduce and distribute copies of the Work or Derivative Works thereof in any medium, with or without modifications, and in Source or Object form, provided that You meet the following conditions:

- a. You must give any other recipients of the Work or Derivative Works a copy of this License; and
- b. You must cause any modified files to carry prominent notices stating that You changed the files; and

c. You must retain, in the Source form of any Derivative Works that You distribute, all copyright, patent, trademark, and attribution notices from the Source form of the Work, excluding those notices that do not pertain to any part of the Derivative Works; and

d. If the Work includes a "NOTICE" text file as part of its distribution, then any Derivative Works that You distribute must include a readable copy of the attribution notices contained within such NOTICE file, excluding those notices that do not pertain to any part of the Derivative Works, in at least one of the following places: within a NOTICE text file distributed as part of the Derivative Works; within the Source form or documentation, if provided along with the Derivative Works; or, within a display generated by the Derivative Works, if and wherever such third-party notices normally appear. The contents of the NOTICE file are for informational purposes only and do not modify the License. You may add Your own attribution notices within Derivative Works that You distribute, alongside or as an addendum to the NOTICE text from the Work, provided that such additional attribution notices cannot be construed as modifying the License.

You may add Your own copyright statement to Your modifications and may provide additional or different license terms and conditions for use, reproduction, or distribution of Your modifications, or for any such Derivative Works as a whole, provided Your use, reproduction, and distribution of the Work otherwise complies with the conditions stated in this License.

5. Submission of Contributions. Unless You explicitly state otherwise, any Contribution intentionally submitted for inclusion in the Work by You to the Licensor shall be under the terms and conditions of this License, without any additional terms or conditions. Notwithstanding the above, nothing herein shall supersede or modify the terms of any separate license agreement you may have executed with Licensor regarding such Contributions.

6. Trademarks. This License does not grant permission to use the trade names, trademarks, service marks, or product names of the Licensor, except as required for reasonable and customary use in describing the origin of the Work and reproducing the content of the NOTICE file.

7. Disclaimer of Warranty. Unless required by applicable law or agreed to in writing, Licensor provides the Work (and each Contributor provides its Contributions) on an "AS IS" BASIS, WITHOUT WARRANTIES OR CONDITIONS OF ANY KIND, either express or implied, including, without limitation, any warranties or conditions of TITLE, NON-INFRINGEMENT, MERCHANTABILITY, or FITNESS FOR A PARTICULAR PURPOSE. You are solely responsible for determining the appropriateness of using or redistributing the Work and assume any risks associated with Your exercise of permissions under this License.

8. Limitation of Liability. In no event and under no legal theory, whether in tort (including negligence), contract, or otherwise, unless required by applicable law (such as deliberate and grossly negligent acts) or agreed to in writing, shall any Contributor be liable to You for damages, including any direct, indirect, special, incidental, or consequential damages of any character arising as a result of this License or out of the use or inability to use the Work (including but not limited to damages for loss of goodwill, work stoppage, computer failure or malfunction, or any and all other commercial damages or losses), even if such Contributor has been advised of the possibility of such damages.

9. Accepting Warranty or Additional Liability. While redistributing the Work or Derivative Works thereof, You may choose to offer, and charge a fee for, acceptance of support, warranty, indemnity, or other liability obligations and/or rights consistent with this License. However, in accepting such obligations, You may act only on Your own behalf and on Your sole responsibility, not on behalf of any other Contributor, and only if You agree to indemnify, defend, and hold each Contributor harmless for any liability incurred by, or claims asserted against, such Contributor by reason of your accepting any such warranty or additional liability.

END OF TERMS AND CONDITIONS